

# MIRRORSTONE

INFRARED HEATING

## IR PANEL HEATER MANUAL

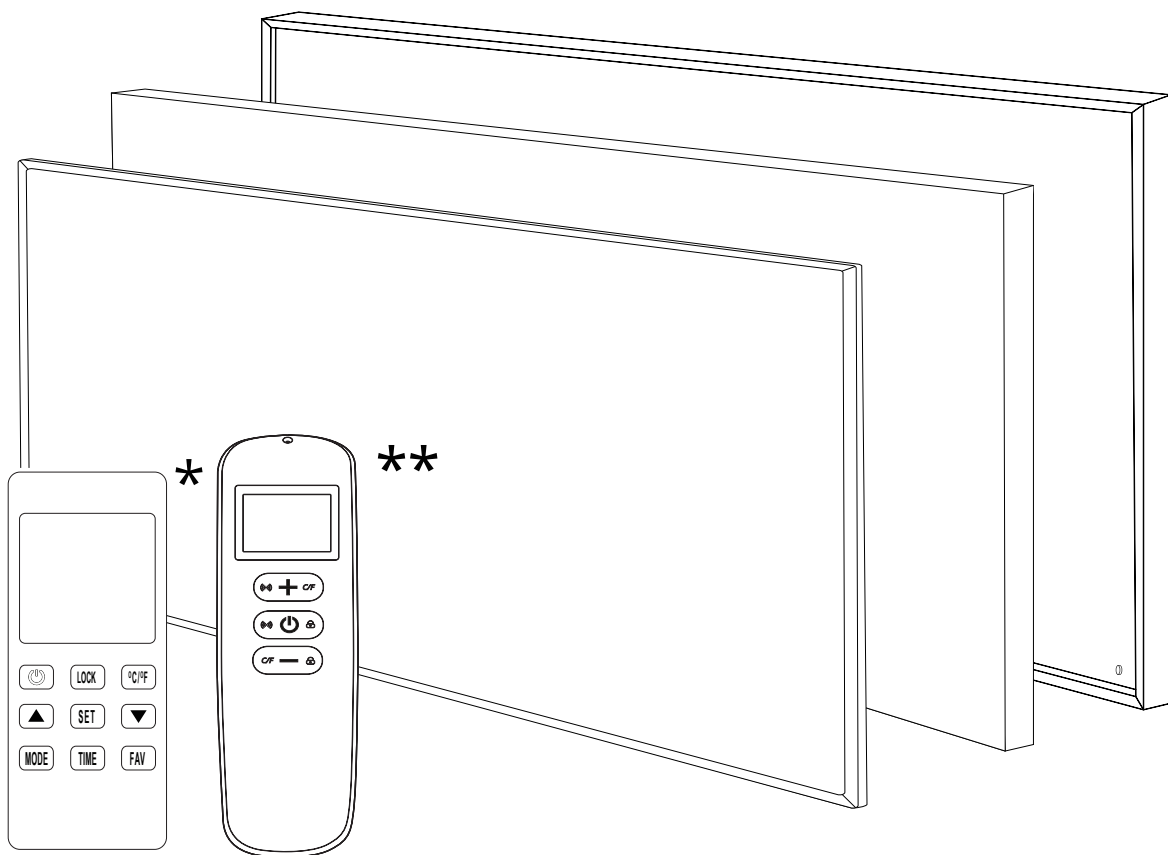

- Classic • Frameless • NXT GEN • Nexus
- Image • Custom Image • Glass & Mirror Range



- \* Remote control only available with NXT Gen panels
- \*\* Remote control only available with Nexus, Glass & Mirror panels

# CONTENTS

---

1. INTRO	4
2. PRECAUTIONS	5
3. SPECS TABLE	6
4. SUSPENSION KIT INSTALLATION (SEPARATELY SOLD)	7
5. CEILING BRACKET INSTALLATION (SEPARATELY SOLD)	9
6. PANEL STAND INSTALLATION (SEPARATELY SOLD)	10
7. CLASSIC INFRARED HEATING PANELS	11
7a. Included In The Box	12
7b. Device Structure	13
7c. Wall Installation	14
8. PREMIUM FRAMELESS INFRARED HEATING PANELS	15
8a. Included In The Box	16
8b. Device Structure	17
8c. Wall Installation	18
9. NXT GEN INFRARED HEATING PANELS	19
9a. Included In The Box	20
9b. Device Structure	21
9c. NXT Gen Remote Control Specs	22
9d. Built-In NXT Gen Receiver Specs	22
9e. NXT Gen Remote Control Diagram	23
9f. NXT Gen Remote LCD Display	23
9g. Built-In NXT Gen Receiver Diagram	24
9h. Wall Installation	25
9i. Pairing Your NXT Gen Remote	26
9j. Basic Functions	27
9k. Electronic Temperature Control	27
9l. Timer & Temperature Settings	28
9m. Open Window Mode	31
9n. Unpairing Your NXT Gen Remote	31

<b>10. NEXUS WI-FI/IMAGE/CUSTOM IMAGE INFRARED HEATING PANELS</b>	<b>33</b>
10a. Included In The Box	34
10b. Device Structure	35
10c. Wall Installation	36
<b>11. GLASS/MIRROR INFRARED HEATING PANELS</b>	<b>37</b>
11a. Included In The Box	38
11b. Device Structure	39
11c. Wall Installation	40
<b>12. NEXUS FEATURES FOR NEXUS/GLASS/MIRROR INFRARED HEATING PANELS</b>	<b>41</b>
12a. Nexus Wi-Fi Remote Control Specs	42
12b. Built-In Receiver Wi-Fi Receiver Specs	42
12c. Nexus Wi-Fi Remote Control Diagram	43
12d. Nexus Wi-Fi Remote LCD Display	44
12e. Built-In Nexus Wi-Fi Receiver Diagram (one for nexus, one for glass/mirror)	44
12f. Pairing Your Nexus Wi-Fi Remote	45
12h. Basic Functions	45
12i. Electronic Temperature Control	46
12j. Advanced Features	46
12k. Connecting Your Nexus Wi-Fi Panel To Wi-Fi	47
<b>13. MAINTENANCE &amp; SERVICING</b>	<b>51</b>
<b>14. TROUBLESHOOTING</b>	<b>52</b>
<b>15. DISPOSAL</b>	<b>53</b>

# INTRO

---

Thank you for purchasing your new infrared heater. When used properly, it should provide you with plenty of eco-friendly, energy saving infrared heat for many years to come.

Please keep this manual safe for future reference. It contains lots of important information that will help you manage and look after your panel and ensure it lasts for as long as possible.

Before doing anything with your panel, please carefully read the precautions on the following page. Failure to do so may result in injury, or the voiding of your warranty.

Note: This manual covers every model we offer, so not all the sections will apply to you. Please make sure that you are reading the correct section for your heater before doing anything.

# PRECAUTIONS

---

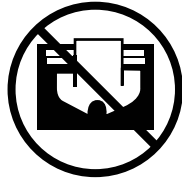

No Covering

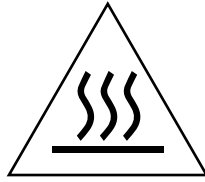

Do Not Touch



Do Not Spray

1. To prevent burns or injuries related to prolonged contact with the heating panel, children, those who suffer from sensitive skin, the elderly, the sick or those who are taking any medication that causes drowsiness should take extra care around the appliance.
2. Do not damage, destroy, change, bend, stretch or press the power cord, otherwise it may result in fire or electric shock.
3. Ensure that the usage voltage remains between 220-240V, 50Hz and that the power supply is grounded.
4. The heating panels will draw more current than small appliances when in operation. 180W, 350W, 580W, 700W & 900W panels will require a separate 5A socket, and 1200W panels will require a 6A socket.
5. Keep the heating panel away from flammable products to prevent the risk of fire.
6. Please ensure that there are no objects placed within 30cm of the front of the panel, and within 30cm of the sides of the panel.
7. Please ensure that the panel is not mounted directly to the ceiling, unless you have a suspended ceiling. For all other ceiling installations, either a suspension kit with a minimum gap of 50mm between the panel and ceiling must be used, or a ceiling bracket. Glass & Mirror Panels should not be installed on a ceiling.
8. Please do not jump or stand on the panel, or apply strong pressure to it.
9. Never cover the heater with any materials that retain heat well, such as towels, quilts or carpets, etc.
10. Be sure to unplug the power cord from the mains in the event that you need to clean the heating panel, and wait until it has completely cooled down. Please ensure that you use a dry cloth, and avoid using gasoline or Acetone on the appliance.

# SPECS TABLE

Available Sizes		Rated Power	Amps	Heated Area
Classic	295mm x 595mm	180W	0.75A	2 - 3m <sup>2</sup>
	595mm x 595mm	350W	1.46A	5 - 6m <sup>2</sup>
	595mm x 995mm	580W	2.42A	9 - 10m <sup>2</sup>
	595mm x 1195mm	700W	2.92A	11 - 12m <sup>2</sup>
	795mm x 1195mm	900W	3.75A	15 - 16m <sup>2</sup>
	995mm x 1195mm	1200W	5A	19 - 20m <sup>2</sup>
Available Sizes		Rated Power	Amps	Heated Area
Frameless	595mm x 595mm	350W	1.46A	5 - 6m <sup>2</sup>
	605mm x 1005mm	580W	2.42A	9 - 10m <sup>2</sup>
	595mm x 1195mm	700W	2.92A	11 - 12m <sup>2</sup>
Available Sizes		Rated Power	Amps	Heated Area
Nexus / NXT Gen / Image / Custom	295mm x 1195mm	350W	1.46A	2 - 3m <sup>2</sup>
	595mm x 595mm	350W	1.46A	5 - 6m <sup>2</sup>
	595mm x 995mm	580W	2.42A	9 - 10m <sup>2</sup>
	595mm x 1195mm	700W	2.92A	11 - 12m <sup>2</sup>
	795mm x 1195mm	900W	3.75A	15 - 16m <sup>2</sup>
	995mm x 1195mm	1200W	5A	19 - 20m <sup>2</sup>
Available Sizes		Rated Power	Amps	Heated Area
Glass	600mm x 800mm	450W	1.9A	7 - 8m <sup>2</sup>
	600mm x 1000mm	580W	2.42A	9 - 10m <sup>2</sup>
	600mm x 1200mm	700W	2.92A	11 - 12m <sup>2</sup>
Available Sizes		Rated Power	Amps	Heated Area
Mirror	600mm x 600mm	320W	1.33A	5 - 6m <sup>2</sup>
	850mm diameter	320W	1.6A	5 - 6m <sup>2</sup>
	600mm x 800mm	450W	2A	7 - 8m <sup>2</sup>
	600mm x 1000mm	580W	2.5A	9 - 10m <sup>2</sup>
	600mm x 1200mm	700W	3A	11 - 12m <sup>2</sup>

# SUSPENSION KIT INSTALLATION (SEPARATELY SOLD)

---

Suspension kits (sold separately) should only be used for ceiling installations, and if there is no suspended ceiling.

*Works with All Classic Panels (except 180W), All NXT Gen, All Nexus.*

**Ax4**

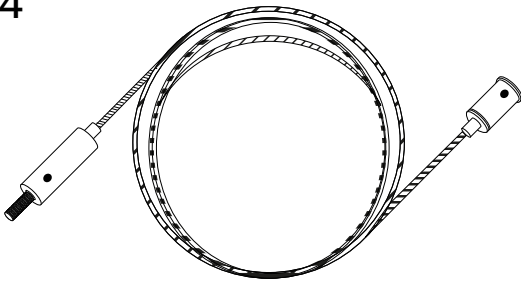

**B1x4**



**B2x4**

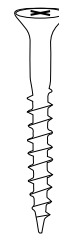

4 x Suspension Cable (A)

4 x Wall Plugs (B1)

4 x Screws (B2)

Please note that if you would like to install your panel on your ceiling, you must use a Suspension Kit and leave a minimum of 50mm clearance between the ceiling and panel.

You must not install the panel directly onto the ceiling.

Suspension kits (sold separately) should only be used for ceiling installations, and if there is no suspended ceiling.

*Your Suspension Kit will also come with 4 x Nuts, but these are not required for installation.*

1. Having drilled into your ceiling, insert the Wall Plug (B1) into your ceiling.
2. Take the end of the Suspension Cable (A1) that does not have the screw protruding from the cylinder, and unscrew the cable from the Cylinder Head.
3. Feed the Screw (B2) through the end of the Cylinder Head, so that it sticks out of the end of the Cylinder Head.
4. Insert the Screw (B2) into the Wall Plug, so that the Cylinder Head is now fixed into the ceiling.
5. Taking the end of the Cable (A1) that was unscrewed in step 2, now screw it back into the Cylinder Head that is affixed onto the ceiling. The Cable (A) should now be affixed to the ceiling.

6. Remove the screws from the back of the frame of the Heating Panel.
7. Take the loose end of the Cable (A2), and screw it into the holes that are now in the back of the frame of the Heating Panel.
8. Repeat steps 1 to 7 for the other 3 remaining Cables (A)

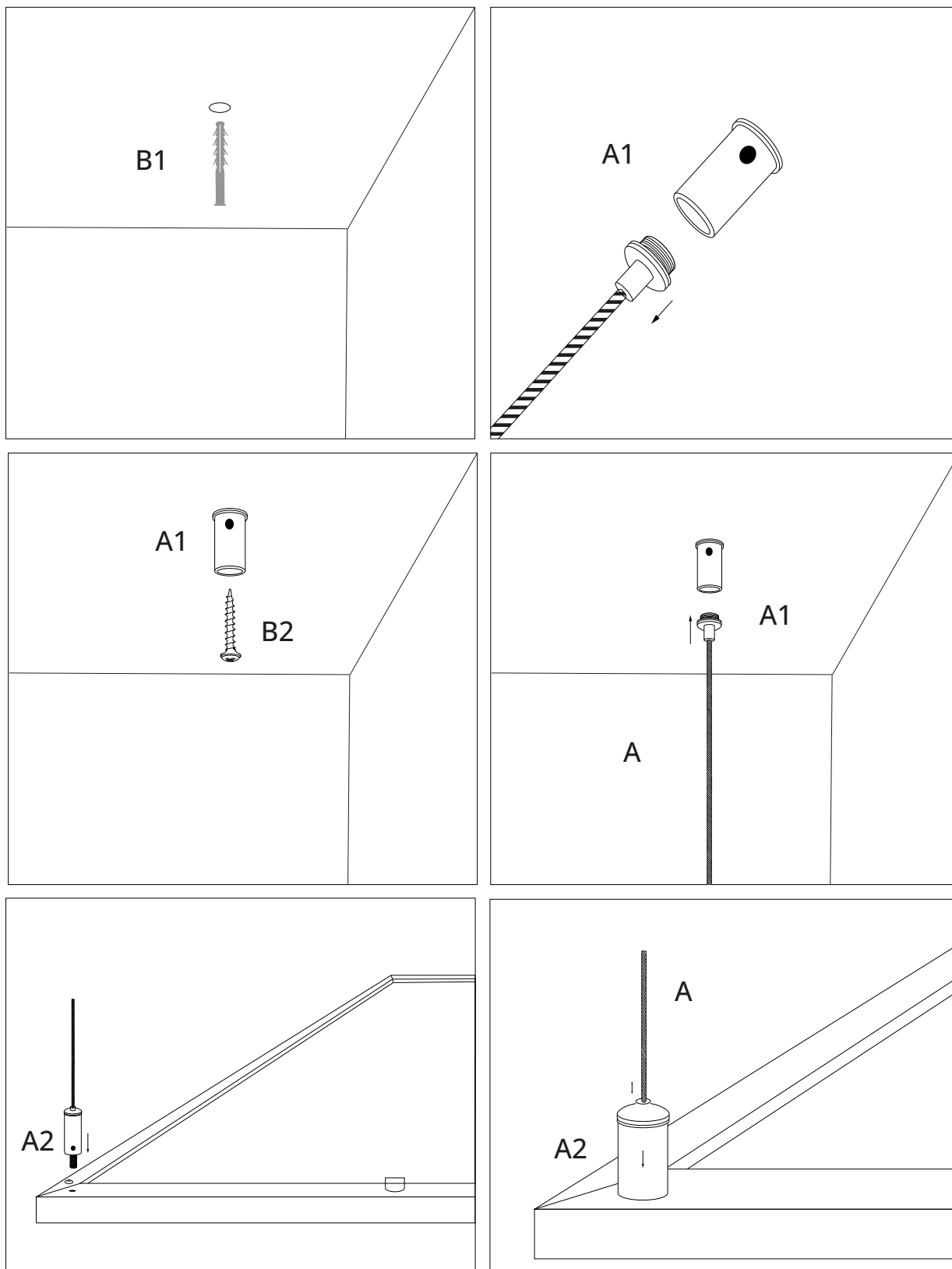



# CEILING BRACKET INSTALLATION (SEPARATELY SOLD)

350mm Bracket is only compatible with 350W, 580W, 700W NXT Gen, Nexus & Frameless Panels, & 580W, 700W Classic Panels.

500mm Bracket is only compatible with 900W Classic, NXT Gen & Nexus Panels.

580mm Bracket is only compatible with 1200W Classic, NXT Gen and Nexus Panels.

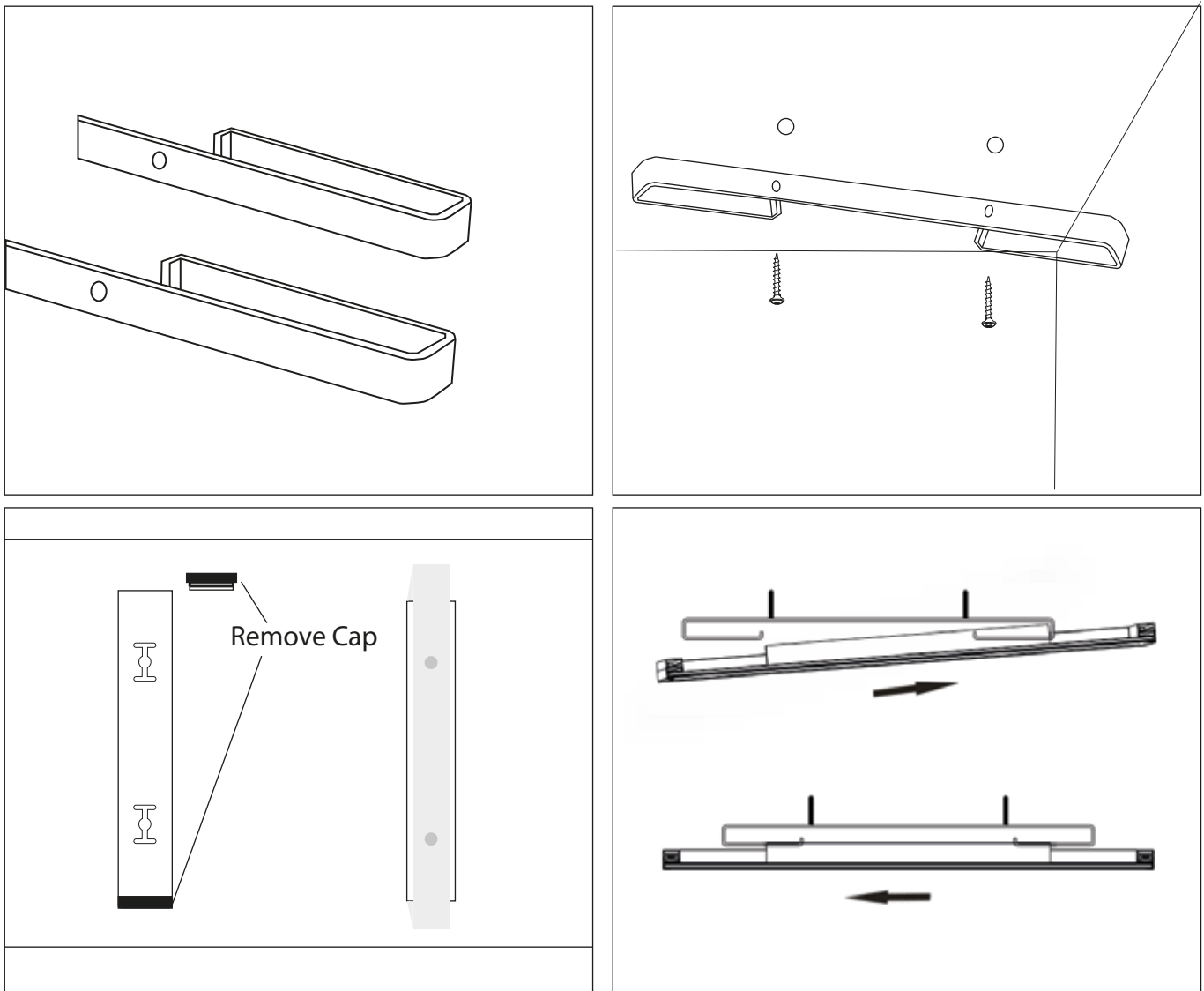

1. Drill into your ceiling and mount both ceiling brackets.
2. Remove the end caps from the aluminium alloy hanging bracket on the back of your panel.
3. Carefully slide the panel hanging brackets over the ceiling bracket and ensure it is held in place.

# PANEL STAND INSTALLATION (SEPARATELY SOLD)

The Panel Stand (sold separately) allows you to have your heater free-standing on the floor, and can also be moved from room to room too.

*Compatible with all Classic, NXT Gen, Nexus Wi-Fi, Image & Custom Image Panels. We recommend one pair of panel stands for sizes up to 700W, and two pairs of panel stands for 900W & 1200W sizes.*

- Place the panel in the slot on the top of the panel stand, then turn the screw in the panel stand so that it is held in place through tension.
- Repeat for the second Stand.

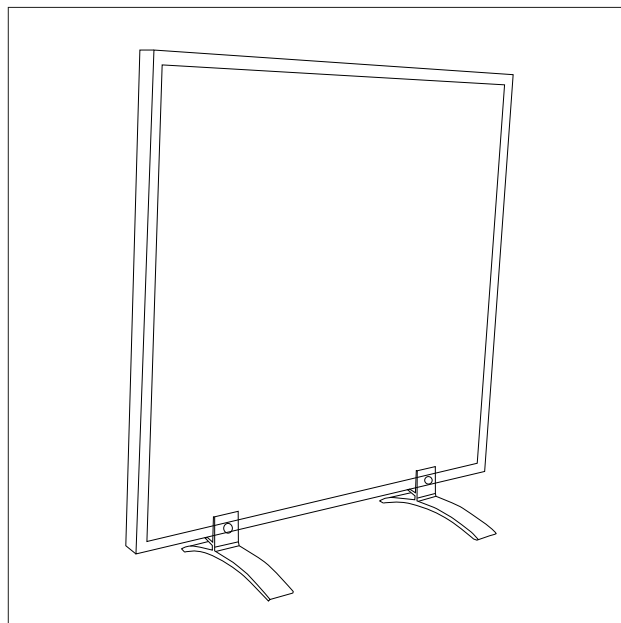
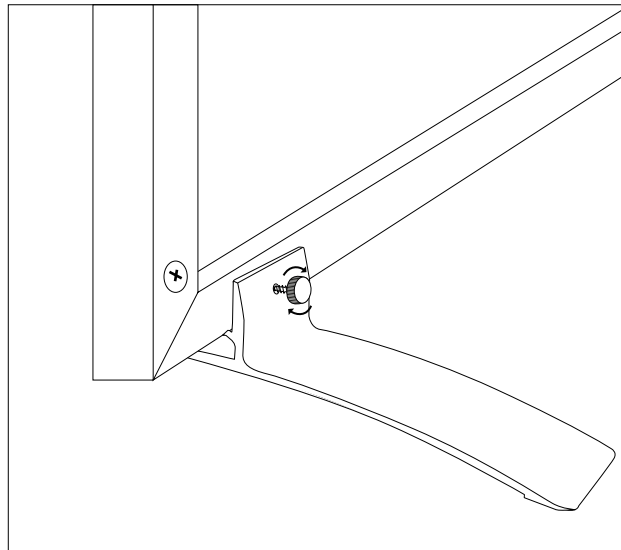

---

# CLASSIC INFRARED HEATING PANELS

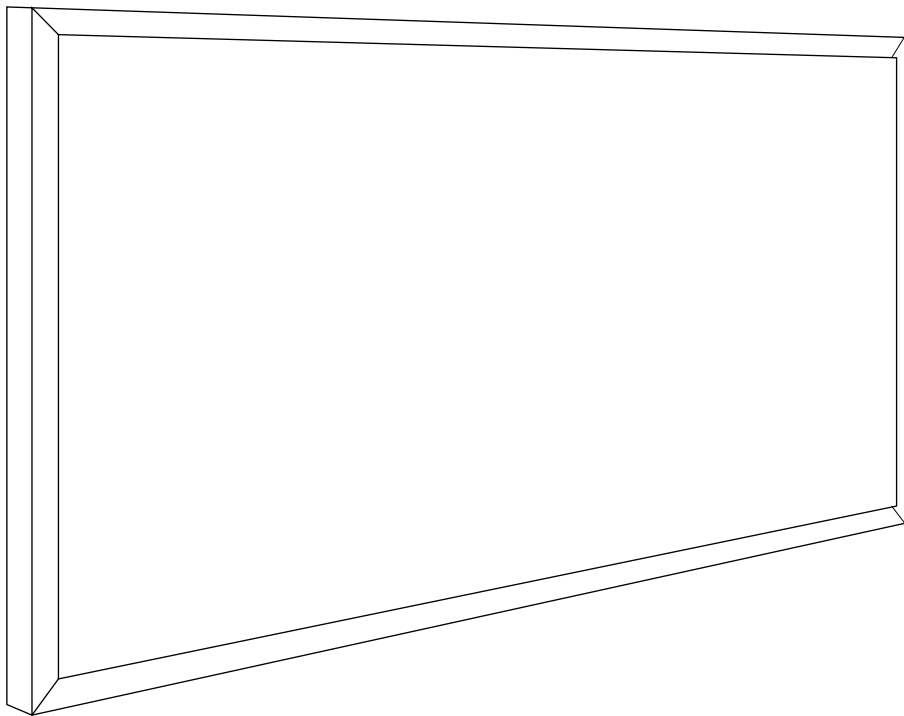

## INCLUDED IN THE BOX

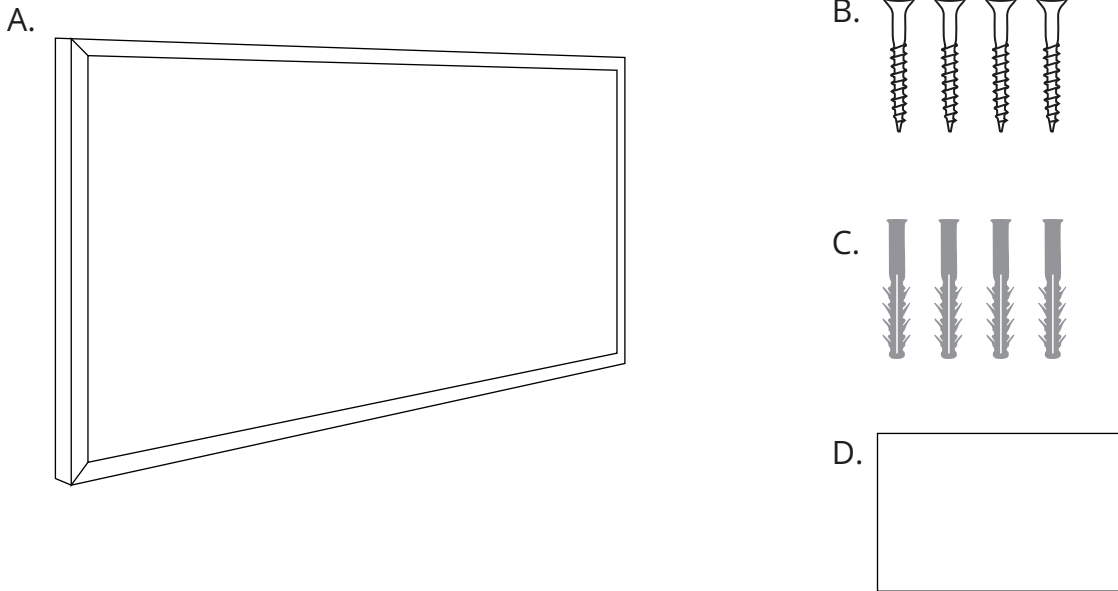

- A. Infrared Heater
- B. Screws
- C. Wall Plugs
- D. Mounting Template

- This infrared panel heater is designed to provide an efficient, comfortable and healthy heating system for all domestic users and homeowners.
- This infrared panel heater can reduce air circulation and help create and maintain a clean, silent and dust free environment.
- All infrared panel heaters should be wall mounted. If you would like to mount the panel on your ceiling, either use a suspension kit with a minimum 50mm gap, a set of ceiling brackets, or install it in a suspended ceiling. Glass & Mirror Panels should not be installed on a ceiling.
- A wide range of panels are available in varying sizes, wattages and frames.

# DEVICE STRUCTURE

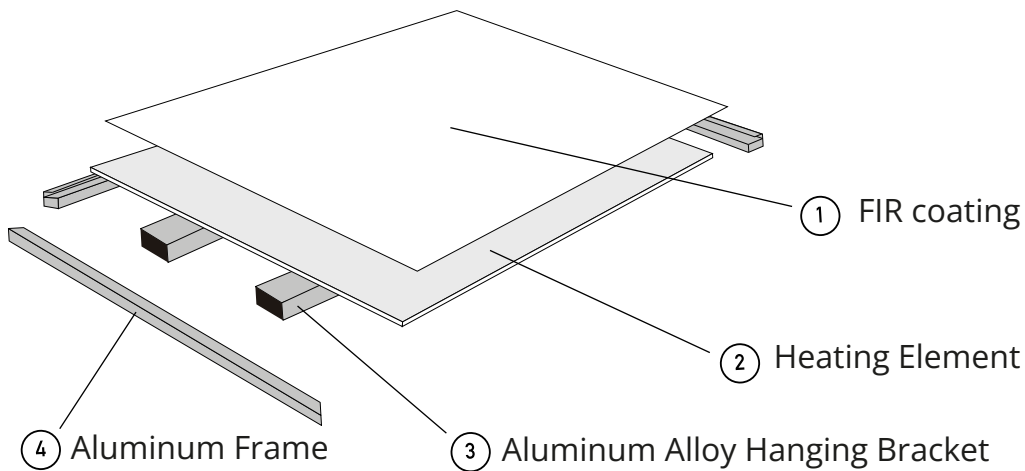

- Most of our panels come with a premium FIR coating that helps maximise the performance of your heating. It can withstand temperatures of up to 200°C without yellowing.
- The carbon crystal heating element will distribute clean and efficient infrared heat throughout your space.
- The hanging bracket can be used to hang your panel on the wall, or used alongside your suspension kit or ceiling bracket.
- The frame will be pre-fitted to your panel, providing a stylish finish.

You may need more than one panel to sufficiently warm your room. To calculate how many watts you will need, use the following formula.

Length (m) x Width (m) x Height (m) = Volume (m<sup>3</sup>)

For well insulated properties: Volume (m<sup>3</sup>) x 25 = Wattage Requirement

For moderately insulated properties: Volume (m<sup>3</sup>) x 30 = Wattage Requirement

For poorly insulated properties: Volume (m<sup>3</sup>) x 35 = Wattage Requirement

# WALL INSTALLATION

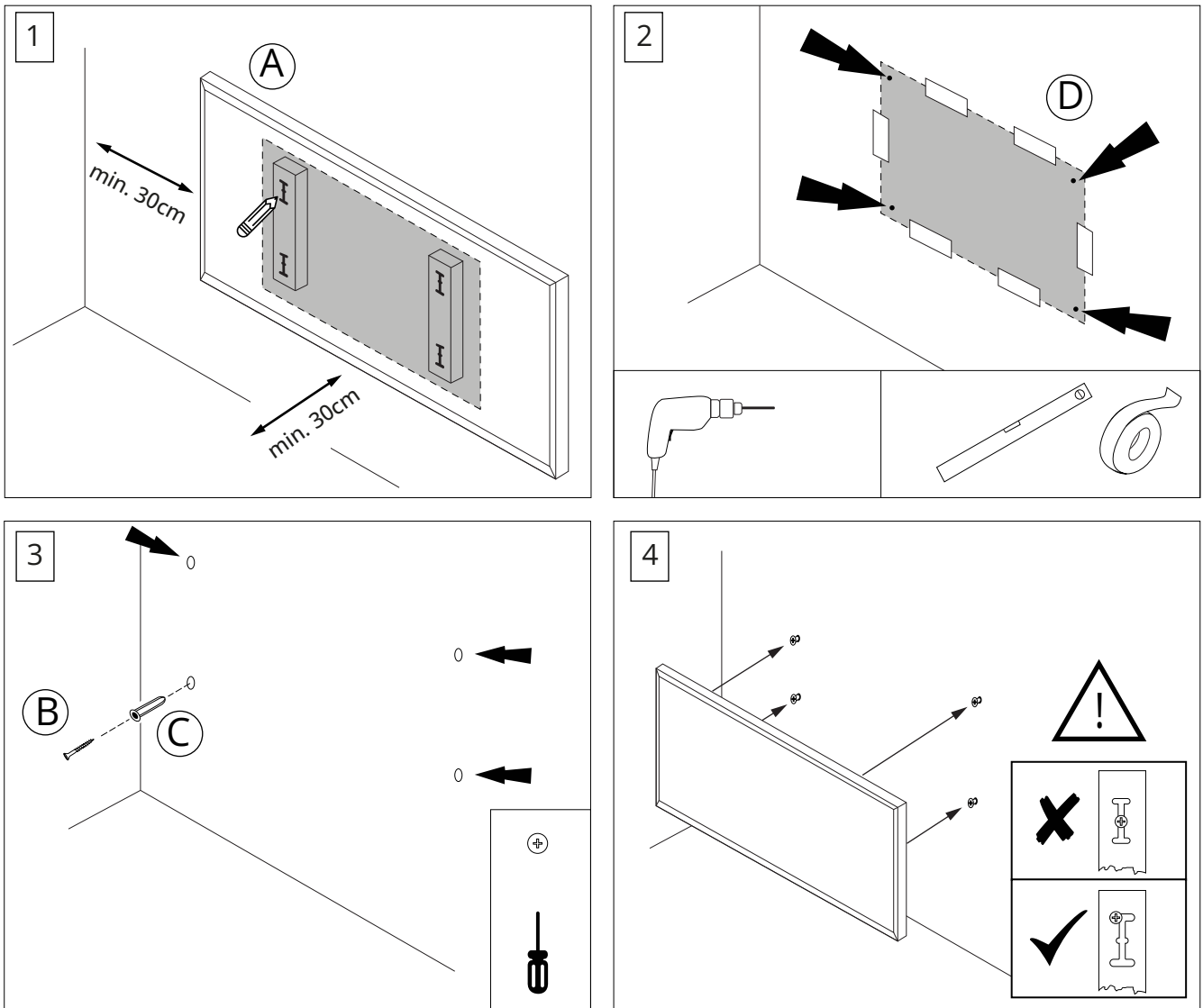

1. Use the supplied paper to cover the back of the panel, and use a pencil to mark the locations of the holes.
2. Use some double sided adhesive tape to fix the paper onto the wall or ceiling. Use this template to drill the holes.
3. Insert the wall plugs into the holes.
4. Insert the screws into the wall plugs. The screws should protrude from the wall by around 5mm.
5. Mount the panel onto the 4 screws.

# PREMIUM FRAMELESS INFRARED HEATING PANELS

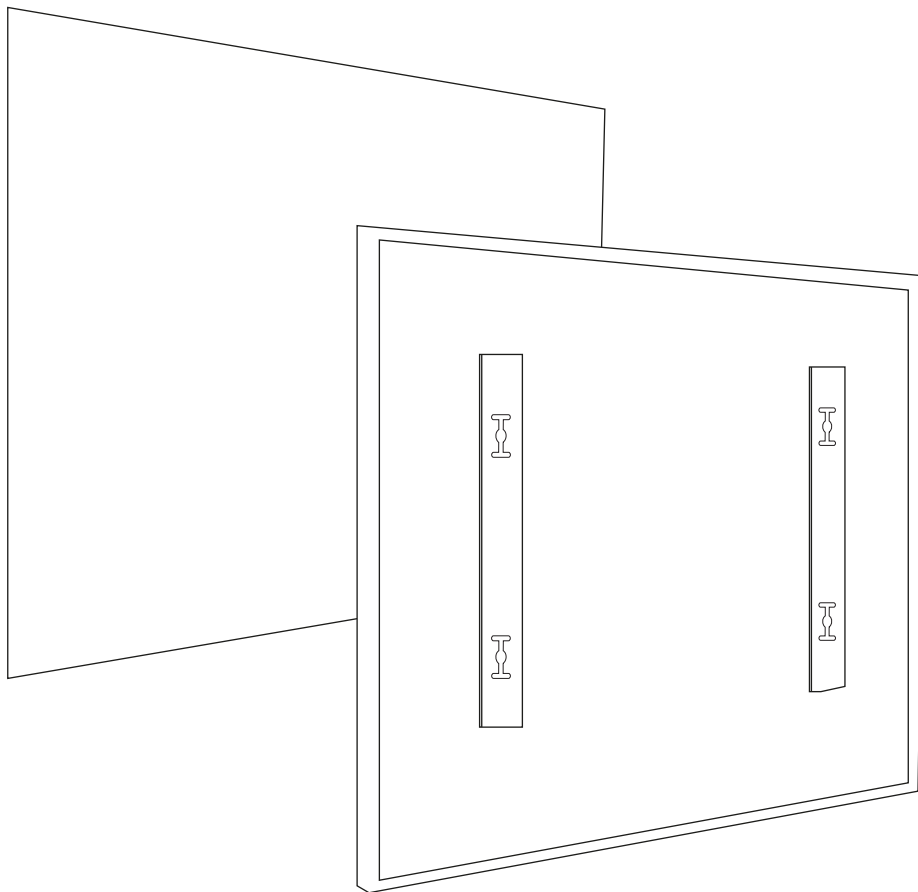

## INCLUDED IN THE BOX

A.

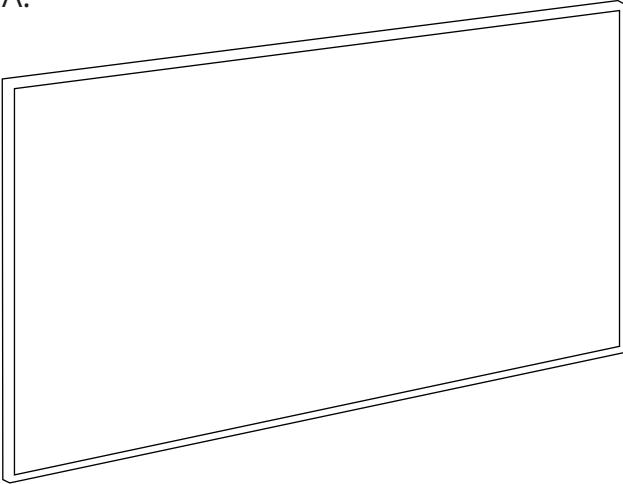

B.

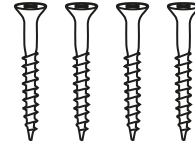

C.

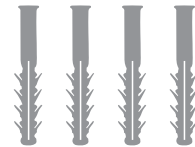

D.



- A. Infrared Heater
- B. Screws
- C. Wall Plugs
- D. Mounting Template

- This infrared panel heater is designed to provide an efficient, comfortable and healthy heating system for all domestic users and homeowners.
- This infrared panel heater can reduce air circulation and help create and maintain a clean, silent and dust free environment.
- All infrared panel heaters should be wall mounted. If you would like to mount the panel on your ceiling, either use a suspension kit with a minimum 50mm gap, a set of ceiling brackets, or install it in a suspended ceiling. Glass & Mirror Panels should not be installed on a ceiling.
- A wide range of panels are available in varying sizes, wattages and frames.



# DEVICE STRUCTURE

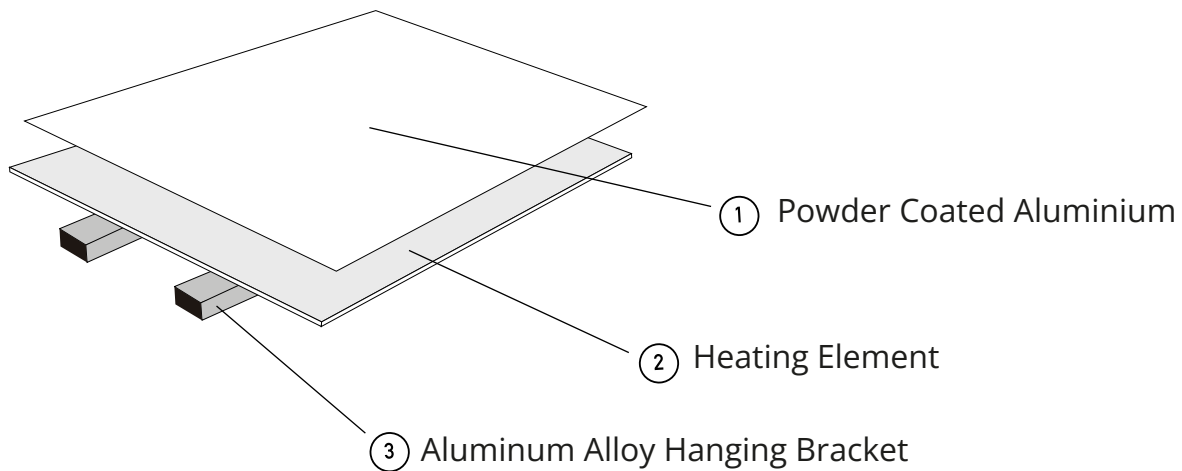

- This panel comes with a Powder Coated Aluminium finish that helps provide a durable build that won't yellow over time, as well as maximising the performance of the heater itself.
- The carbon crystal heating element will distribute clean and efficient infrared heat throughout your space.
- The hanging bracket can be used to hang your panel on the wall, or used alongside your suspension kit or ceiling bracket.

You may need more than one panel to sufficiently warm your room. To calculate how many watts you will need, use the following formula.

Length (m) x Width (m) x Height (m) = Volume (m<sup>3</sup>)

For well insulated properties: Volume (m<sup>3</sup>) x 25 = Wattage Requirement

For moderately insulated properties: Volume (m<sup>3</sup>) x 30 = Wattage Requirement

For poorly insulated properties: Volume (m<sup>3</sup>) x 35 = Wattage Requirement

# WALL INSTALLATION

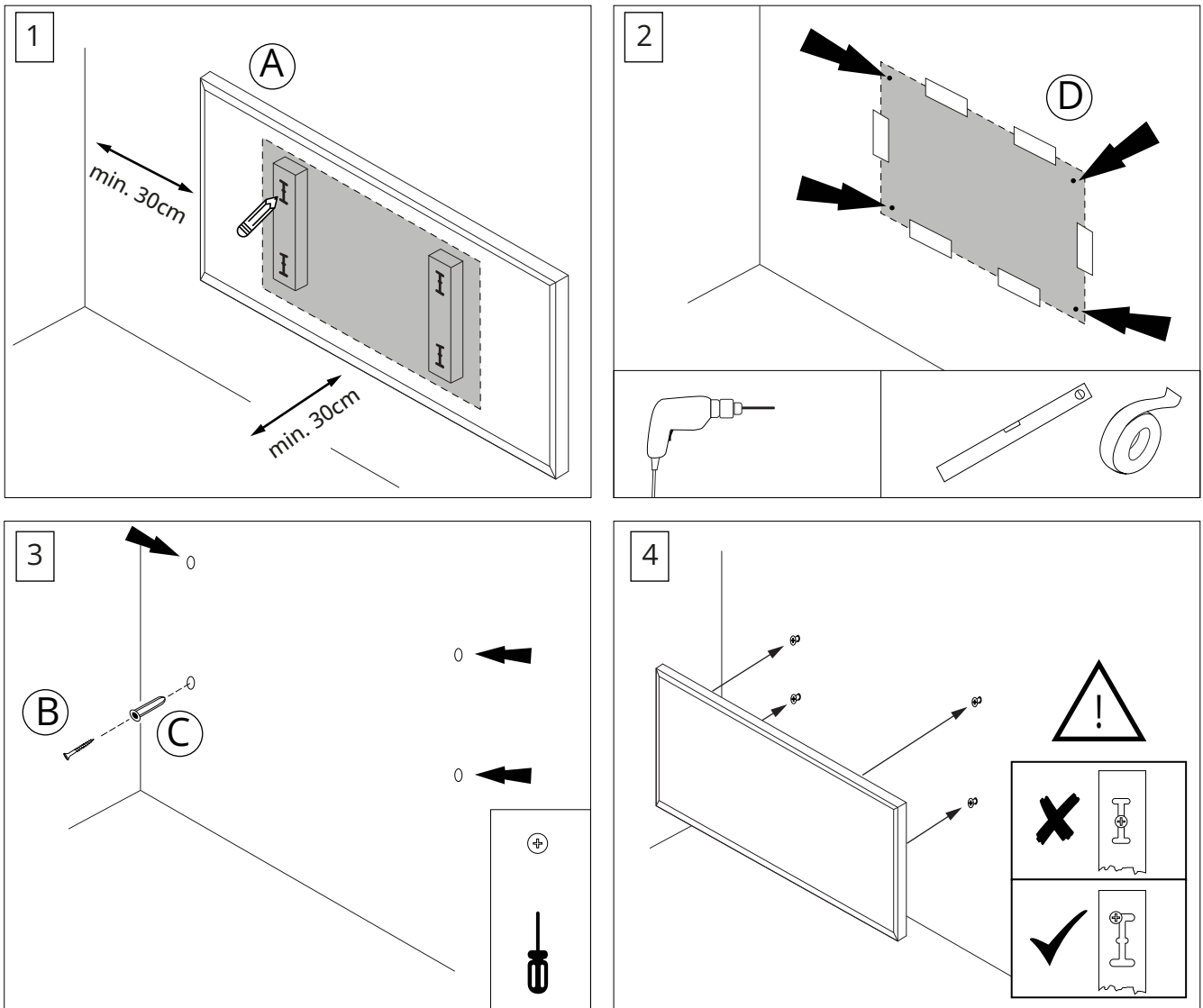

1. Use the supplied paper to cover the back of the panel, and use a pencil to mark the locations of the holes.
2. Use some double sided adhesive tape to fix the paper onto the wall or ceiling. Use this template to drill the holes.
3. Insert the wall plugs into the holes.
4. Insert the screws into the wall plugs. The screws should protrude from the wall by around 5mm.
5. Mount the panel onto the 4 screws.

# NXT GEN INFRARED HEATING PANELS

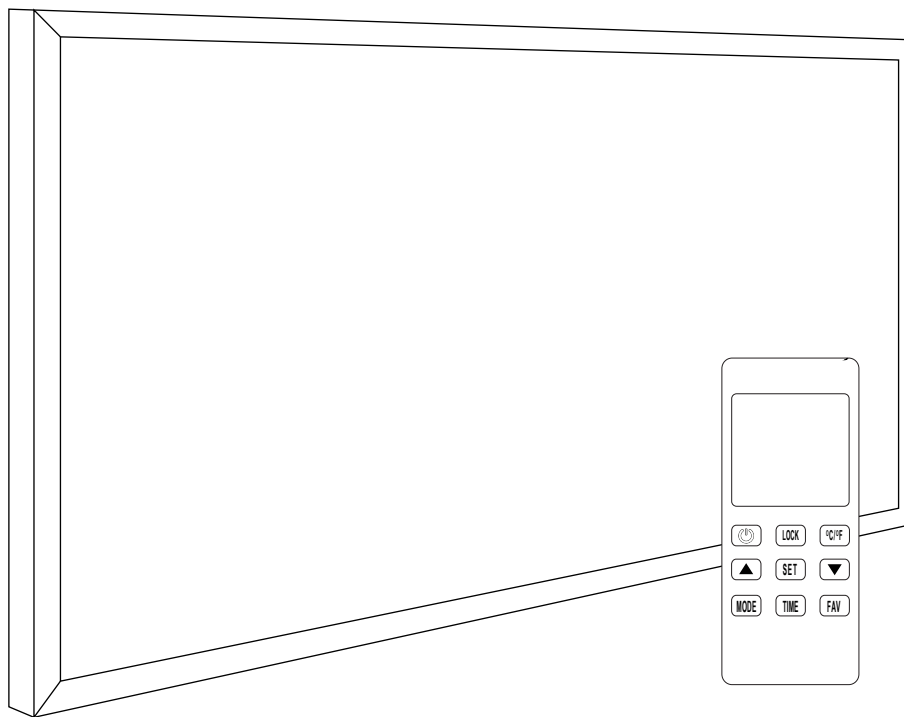

# INCLUDED IN THE BOX

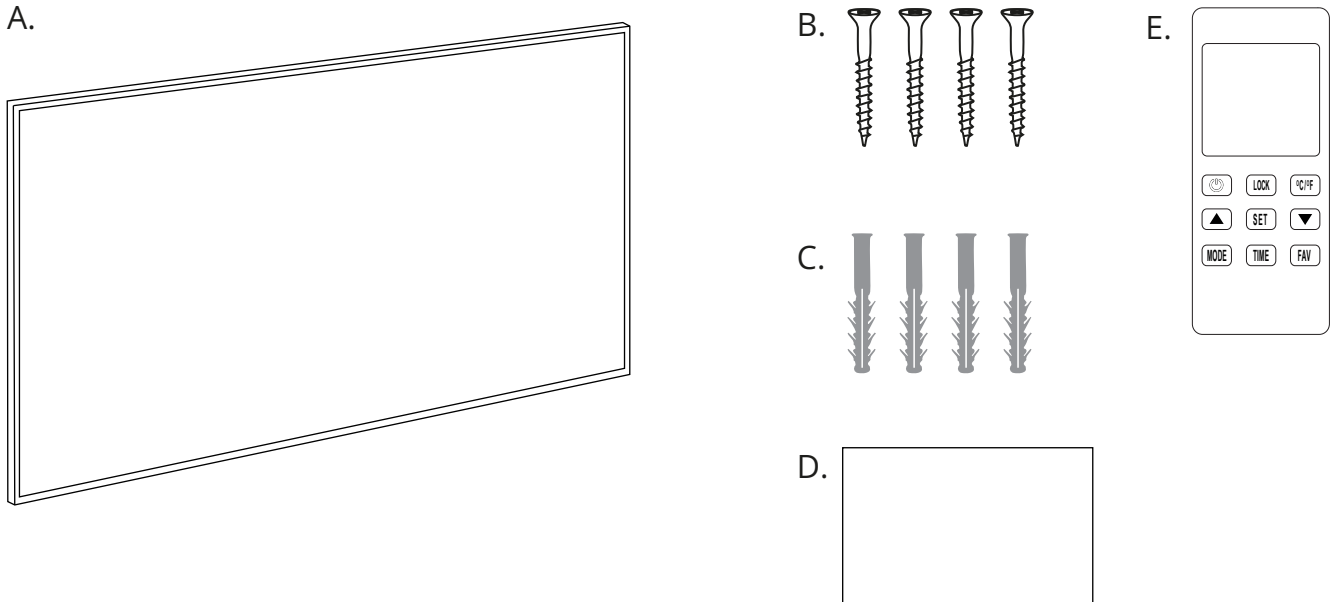

- A. Infrared Heater
- B. Screws
- C. Wall Plugs
- D. Mounting Template
- E. Remote Control (ONLY provided with NXT Gen Panels)

- This infrared panel heater is designed to provide an efficient, comfortable and healthy heating system for all domestic users and homeowners.
- This infrared panel heater can reduce air circulation and help create and maintain a clean, silent and dust free environment.
- All infrared panel heaters should be wall mounted. If you would like to mount the panel on your ceiling, either use a suspension kit with a minimum 50mm gap, a set of ceiling brackets, or install it in a suspended ceiling. Glass & Mirror Panels should not be installed on a ceiling.
- A wide range of panels are available in varying sizes, wattages and frames.

# DEVICE STRUCTURE

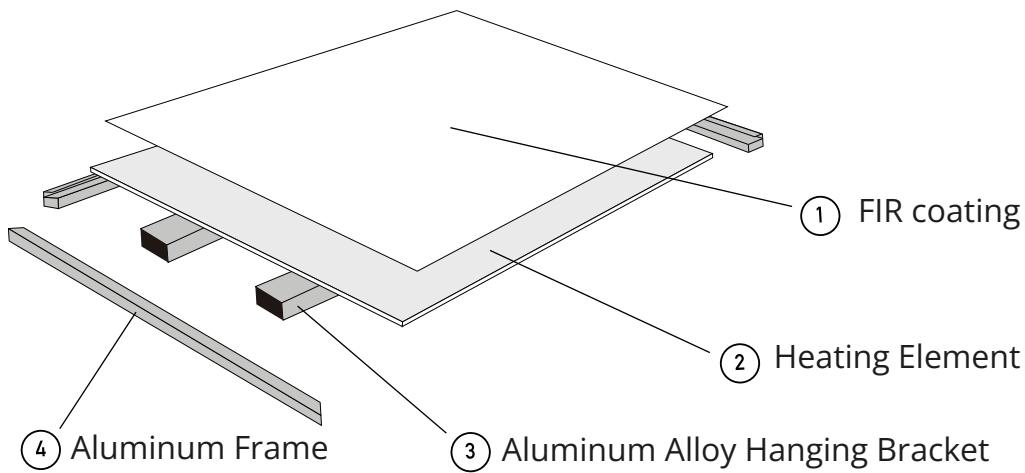

- Most of our panels come with a premium FIR coating that helps maximise the performance of your heating. It can withstand temperatures of up to 200°C without yellowing.
- The carbon crystal heating element will distribute clean and efficient infrared heat throughout your space.
- The hanging bracket can be used to hang your panel on the wall, or used alongside your suspension kit or ceiling bracket.
- The frame will be pre-fitted to your panel, providing a stylish finish.

You may need more than one panel to sufficiently warm your room. To calculate how many watts you will need, use the following formular.

Length (m) x Width (m) x Height (m) = Volume (m<sup>3</sup>)

For well insulated properties: Volume (m<sup>3</sup>) x 25 = Wattage Requirement

For moderately insulated properties: Volume (m<sup>3</sup>) x 30 = Wattage Requirement

For poorly insulated properties: Volume (m<sup>3</sup>) x 35 = Wattage Requirement

---

# NXT GEN REMOTE CONTROL SPECS

NXT Gen Remote and NXT Gen features ONLY available with NXT Gen Panels.

## REMOTE CONTROL

- Battery Powered: DC 3V (2 x 1.5V AAA Batteries, not included)
- Power Consumption: 3V, 0.1mA
- Dimensions: 135mm x 56mm x 18mm (L x W x D)
- Weight: 86g
- Thermostat Target Temperature Range: 5 °C – 35 °C (41 °F – 95 °F)
- Temperature Resolution:  $\pm 1$  °C
- Thermostat Current Temperature Range: 1 °C – 50 °C (Displayed at 0.1 °C increments)
- Accuracy Of Measured Temperature:  $\pm 0.5$  °C



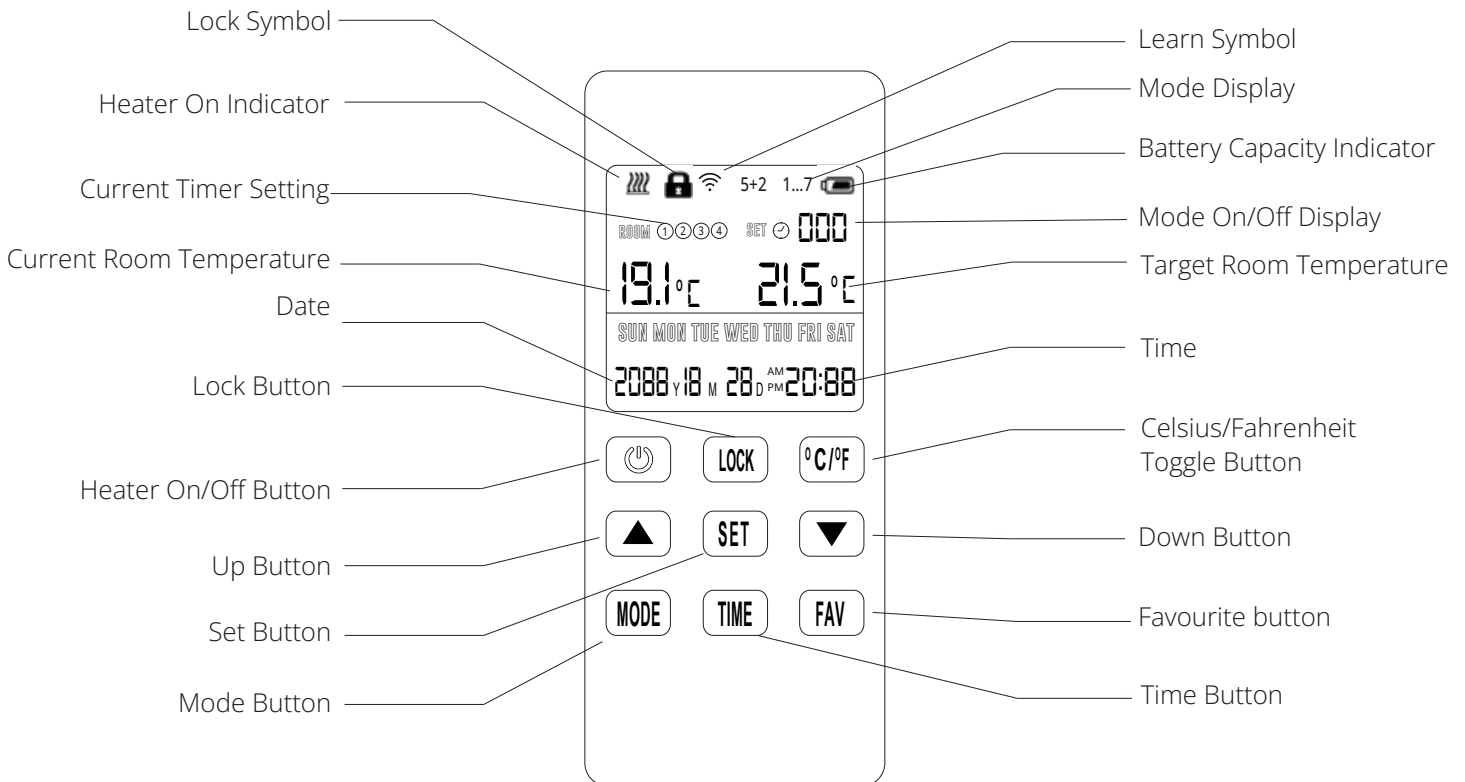

## BUILT IN RECEIVER

- Power Supply: AC 220-240V, 50/60Hz
- Power Consumption: 0.4W
- Integrated Rocker Switch: Remote control override

# NXT GEN REMOTE CONTROL DIAGRAM



# NXT GEN REMOTE LCD DISPLAY

- The  symbol indicates when the IR Panel is beaming out heat.
- The  symbol indicates that the buttons on the remote controller are locked.
- The  indicates when your remote is attempting to pair to your panel.
- The  shows you the current battery level. It will begin to flash when the batteries are low. At this point, you will need to replace the batteries.

# BUILT-IN NXT GEN RECEIVER DIAGRAM

Green override switch  
(remote will be in operation  
when this is switch of OFF)

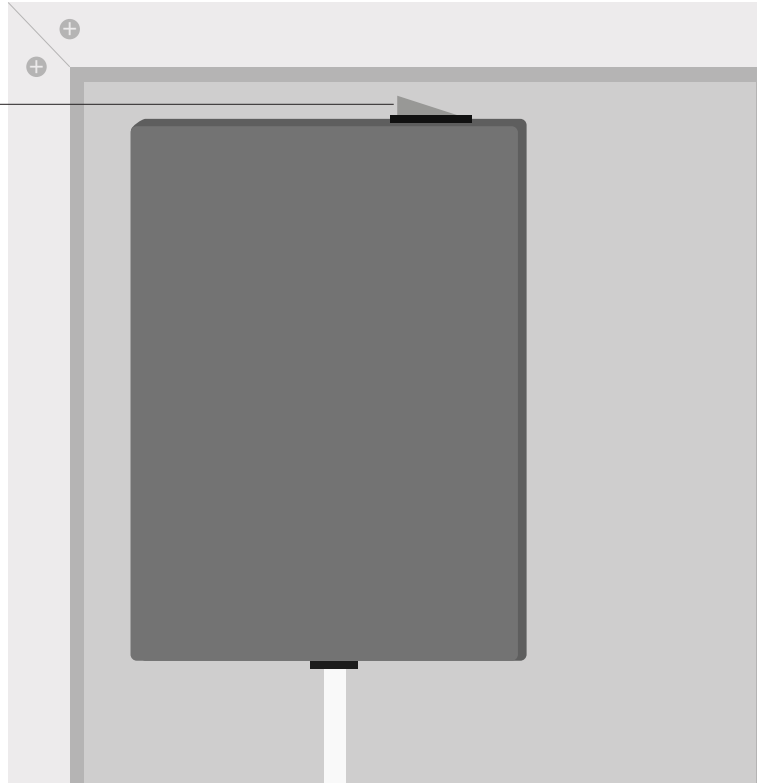



# WALL INSTALLATION

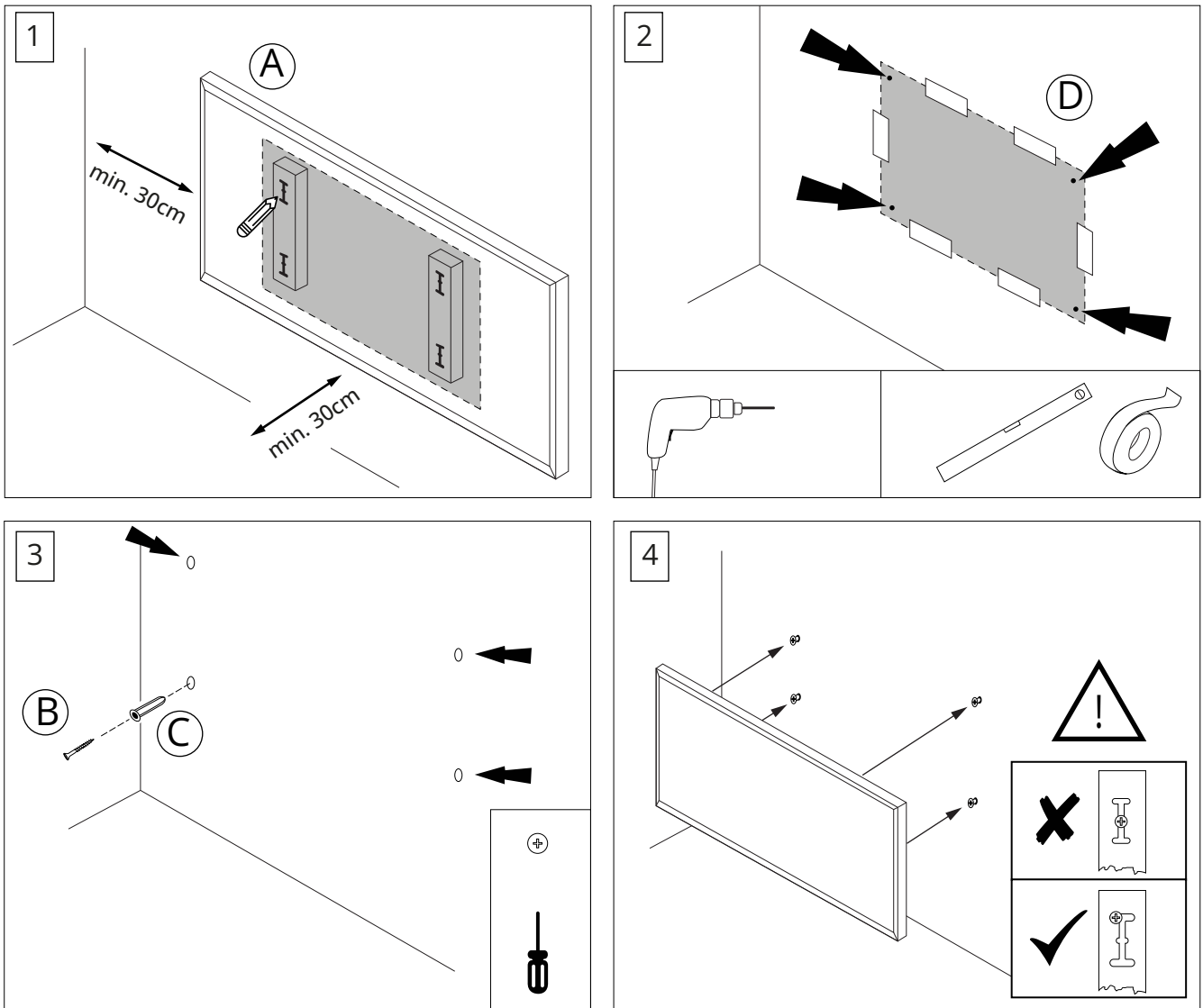

1. Use the supplied paper to cover the back of the panel, and use a pencil to mark the locations of the holes.
2. Use some double sided adhesive tape to fix the paper onto the wall or ceiling. Use this template to drill the holes.
3. Insert the wall plugs into the holes.
4. Insert the screws into the wall plugs. The screws should protrude from the wall by around 5mm.
5. Mount the panel onto the 4 screws.

## PAIRING YOUR NXT GEN REMOTE

---

For a full video guide on how to use your NXT Gen IR Panel remote, please scan the QR code.



- Included with each panel is a remote controller with an LCD digital display. This features an integrated room temperature sensor located at the top of the remote.
- At the back of the panel itself is the integrated receiver that communicates with the remote controller. On this receiver is a green rocker switch. This is the remote override switch so when it is in the Off position, the remote will be in operation, and when it is in the On position, the remote will not work.
- Upon plugging in your IR Panel, the heater will switch on. Ensure that the green switch on the receiver is in the Off position.
- Insert 2 x AAA batteries into the remote, and press the '⏻' button' to switch the remote on.
- To pair the remote with the panel, hold down the 'Mode button' and '°C/°F button' together for 3 seconds. You will hear a beep from the receiver on the back of the panel upon successful pairing. You must pair the remote within 1 minute of the panel being switched on, otherwise, you must switch the panel off, leave it for 10 seconds, and power it back on.
- You can repeat this process to pair the same remote to multiple heaters.
- When the green switch is on, the remote control will not work and the panel will be constantly on.

## BASIC FUNCTIONS

---

- Press the '⏻' button to switch the heater on or off.
- Press the 'C/F toggle button' to change between Celsius and Fahrenheit temperature displays.
- Hold down the 'Lock button' for 3 seconds to lock the remote, and hold it again for 3 seconds to unlock the remote.
- Set the year, month and day by holding down the 'Time' button. Use the 'Up' and 'Down' button to change the year, and then press the 'Time' button again to confirm. You can then select the month using the 'Up' and 'Down' button, confirming your selection using the 'Time' button. Repeat this until you've set the correct date and time.
- Hold down the 'Mode' button for 3 seconds to switch the set timers on and off.
- Hold down the 'Favourite' button for 3 seconds to set a favourite temperature. When you want to quickly switch your target temperature to your favourite temperature, simply press the 'Favourite' button. The default favourite temperature is 24°C

## ELECTRONIC TEMPERATURE CONTROL

---

- Using the 'Up' and 'Down' buttons, you can change the temperature that you would like your room to be. The temperature next to 'Set' on the LCD screen will tell you your current target temperature. The default target temperature when your panel starts up is 19°C.
- The current room temperature as measured by the sensor will be displayed next to 'Room' on the LCD screen.
- If the current room temperature is less than the target temperature by 0.5°C or more, then the panel will switch on.
- Conversely, if the room temperature is higher than the target temperature by 0.5°C or more, then the panel will switch off.

# TIMER & TEMPERATURE SETTINGS

---

There are two programming modes available for you to use: 5+2 mode, and 1-7 mode.

5+2 mode allows you to set up to 4 separate on/off timers for the weekdays and weekends.

1-7 mode allows you to set up to 2 separate on/off timers for any individual day.

- To switch between Manual, 5+2 mode and 1-7 mode, hold down the 'Mode' button. You will see the icons at the top of the LCD display change, indicating which mode you're currently in.

## 5+2 MODE

- To begin setting your timers, hold down the 'Set' button for 3 seconds until you see the '1' icon flashing, along with the 'Mon Tue Wed Thu Fri' icons. The time icon and On will also be flashing on the screen.
- Here, you can adjust the On time for program 1 for the weekdays. Use the 'Up' button to adjust the hour, and use the 'Down' button to adjust the minutes. Once you're happy with your selection, press the 'Set' button.
- Next, you can set the Off time for program 1 for the weekdays. Again, use 'Up' and 'Down' to adjust the hours and minutes respectively. Once you're happy with the timer, press the 'Set' button once more.
- Next, you'll see the temperature flashing on the screen. You can now set the target temperature for the times you set in the previous steps. Use the 'Up' and 'Down' buttons to adjust this accordingly. Once you're happy with the temperature setting, press 'Set' once more.
- You can now repeat the previous steps to set the time and temperature for Program 2, 3 and 4.
- Once done, you can then repeat the same steps to set Program 1-4 for the weekends.

## Tips:

- By default, the start and end times for each setting is set to 00:00, and the temperature 15°C. If you do not adjust the default on/off time of 00:00, then that program setting will be invalid/unused.
- You can use this if you need less than 4 on/off timers throughout the day. Any on/off timers you set for programs 1-4 should not overlap each other.
- The off time should always be later than the on time, otherwise that program will be invalid.
- Once your programs are set, your heater will switch on and off according to the timers, even if the remote is switched off. If you wish to switch your timers off, you can hold down the 'Mode' button to switch your timers on and off.
- The programming mode will time out after 8 seconds without any input and go back to the main screen

- Setting timers is only possible in 5+2 mode and 1-7 mode, and is not possible in Manual mode.

## 1-7 MODE

- To begin setting your timers, hold down the 'Set' button for 3 seconds until you see the '1' icon flashing, along with the 'Mon' icon. The time icon and On will also be flashing on the screen.
- Here, you can adjust the On time for program 1 for Monday. Use the 'Up' button to adjust the hour, and use the 'Down' button to adjust the minutes. Once you're happy with your selection, press the 'Set' button.
- Next, you can set the Off time for program 1 for Monday. Again, use 'Up' and 'Down' to adjust the hours and minutes respectively. Once you're happy with the timer, press the 'Set' button once more.
- Next, you'll see the temperature flashing on the screen. You can now set the target temperature for the times you set in the previous steps. Use the 'Up' and 'Down' buttons to adjust this accordingly. Once you're happy with the temperature setting, press 'Set' once more.
- You can now repeat the previous steps to set the time and temperature for Program 2 for Monday.

## Tips:

- By default, the start and end times for each setting is set to 00:00, and the temperature 15°C. If you do not adjust the default on/off time of 00:00, then that program setting will be
- invalid/unused.  
You can use this if you need less than 2 on/off timers throughout the day.
- Any on/off timers you set for programs 1 and 2 should not overlap each other.
- The off time should always be later than the on time, otherwise that program will be invalid.
- Once your programs are set, your heater will switch on and off according to the timers, even if the remote is switched off. If you wish to switch your timers off, you can hold down the 'Mode' button to switch your timers on and off.
- The programming mode will time out after 8 seconds without any input and go back to the main screen.
- Setting timers is only possible in 5+2 mode and 1-7 mode, and is not possible in Manual mode.

The default timer and temperature settings for 5+2 and 1-7 mode are detailed below:

			Start Time	End Time	Temperature
5+2	Mon-Fri	1	00:00	06:30	17
		2	06:30	08:45	19
		3	08:45	17:00	17
		4	17:00	22:30	19
	Sat-Sun	1	00:00	08:00	17
		2	08:00	14:00	19
		3	14:00	17:30	17
		4	17:30	23:15	19
1-7	Mon	1	06:30	17:00	17
		2	17:00	22:30	19
	Tues	1	06:30	17:00	17
		2	17:00	22:30	19
	Weds	1	06:30	17:00	17
		2	17:00	22:30	19
	Thurs	1	06:30	17:00	17
		2	17:00	22:30	19
	Fri	1	06:30	17:00	17
		2	17:00	22:30	19
	Sat	1	08:00	14:00	19
		2	17:30	23:15	19
	Sun	1	08:00	14:00	19
		2	17:30	23:15	19

The heater can still be turned on and off manually while the timer settings are active, and it will only impact the current timer setting.

---

## OPEN WINDOW MODE

---

- Inside the remote is an open window detection function. This is designed to minimise your energy consumption by switching your IR Panel off when it detects an open window.
- When the remote control detects a drop in temperature by 1.5°C or more within a 3 minute period, it will switch the IR Panel off as having a heater on with an open window is incredibly inefficient.
- When the remote control detects a rise in temperature by 1.5°C or more within a 3 minute period, it will resume normal operation as a result of a closed window.
- You can override the Open Window Mode by simply switching your heater back on using the 'On/Off' button.

## UNPAIRING YOUR NXT GEN REMOTE

---

In some cases, you may want to unpair your remote from your NXT Gen IR Panel. Please follow the steps below to unpair your remote.

- Hold the power button down on the remote for 5 seconds, or until the display on the remote disappears.
- Turn the heater off at the mains, leaving the switch on the heater as it is.
- Remove the batteries from the remote and wait for 10 minutes.
- Turn the heater back on at the mains.
- Follow the remote pairing process again.
- If this does not work, try the above steps but whilst leaving the heater on at the mains during the 10 minute period.

---

## NOTES

- Your date, time and timer settings will be saved even after replacing the batteries.
- Please use alkaline batteries in the remote.
- If none of the buttons on the remote control are working, please try to replace the batteries first.
- Please ensure you change the batteries once the battery icon on the remote begins to flash.
- Do not cover the temperature sensor at the top of the remote control.
- Keep the remote control out in the room where your heater is installed, and avoid putting it in a drawer, in your pocket, under a pillow or anywhere else where the temperature sensor may be blocked, as this may result in the heater not functioning correctly.
- If you will not be using the heater for a prolonged period of time, it is best to remove the batteries from the remote.



---

# NEXUS WI-FI/IMAGE/CUSTOM IMAGE INFRARED HEATING PANELS

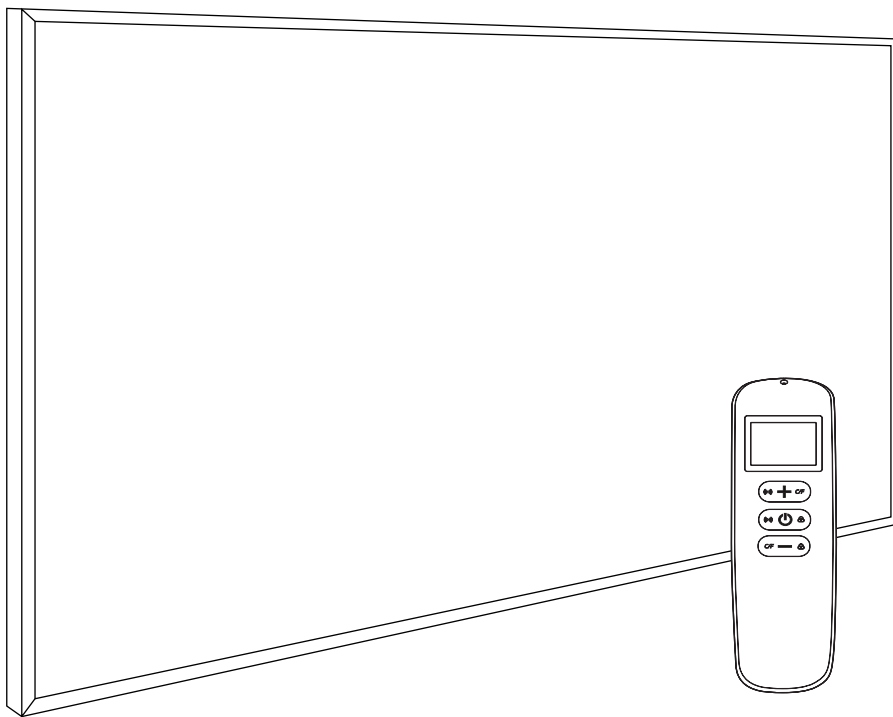

## INCLUDED IN THE BOX

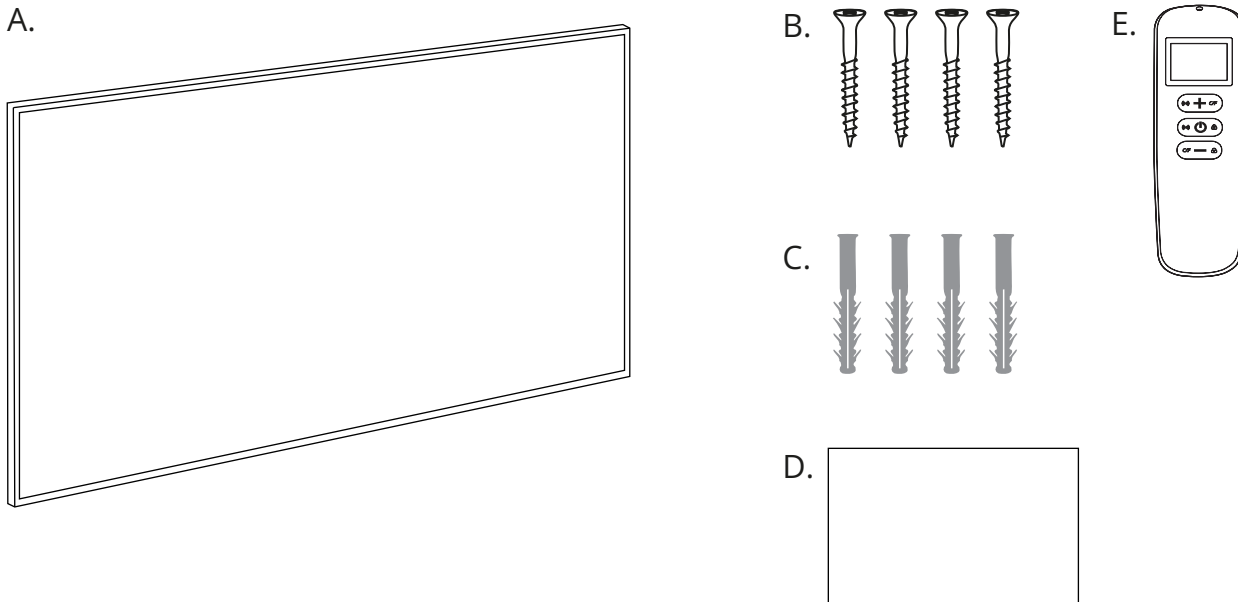

- A. Infrared Heater
- B. Screws
- C. Wall Plugs
- D. Mounting Template
- E. Remote Control (ONLY provided with Nexus, Glass and Mirror IR Heating Panels)

- This infrared panel heater is designed to provide an efficient, comfortable and healthy heating system for all domestic users and homeowners.
- This infrared panel heater can reduce air circulation and help create and maintain a clean, silent and dust free environment.
- All infrared panel heaters should be wall mounted. If you would like to mount the panel on your ceiling, either use a suspension kit with a minimum 50mm gap, a set of ceiling brackets, or install it in a suspended ceiling. Glass & Mirror Panels should not be installed on a ceiling.
- A wide range of panels are available in varying sizes, wattages and frames.

# DEVICE STRUCTURE

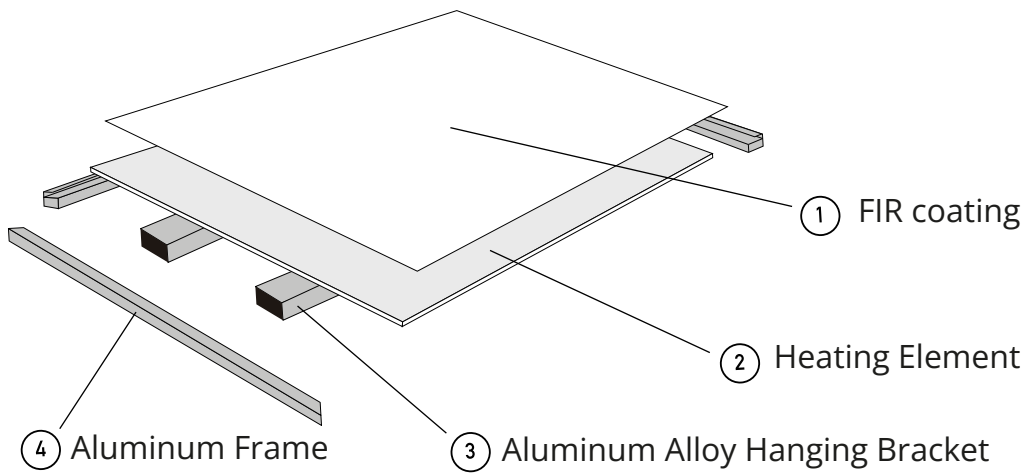

- Most of our panels come with a premium FIR coating that helps maximise the performance of your heating. It can withstand temperatures of up to 200°C without yellowing.
- The carbon crystal heating element will distribute clean and efficient infrared heat throughout your space.
- The hanging bracket can be used to hang your panel on the wall, or used alongside your suspension kit or ceiling bracket.
- The frame will be pre-fitted to your panel, providing a stylish finish.

You may need more than one panel to sufficiently warm your room. To calculate how many watts you will need, use the following formula.

Length (m) x Width (m) x Height (m) = Volume (m<sup>3</sup>)

For well insulated properties: Volume (m<sup>3</sup>) x 25 = Wattage Requirement

For moderately insulated properties: Volume (m<sup>3</sup>) x 30 = Wattage Requirement

For poorly insulated properties: Volume (m<sup>3</sup>) x 35 = Wattage Requirement

# WALL INSTALLATION

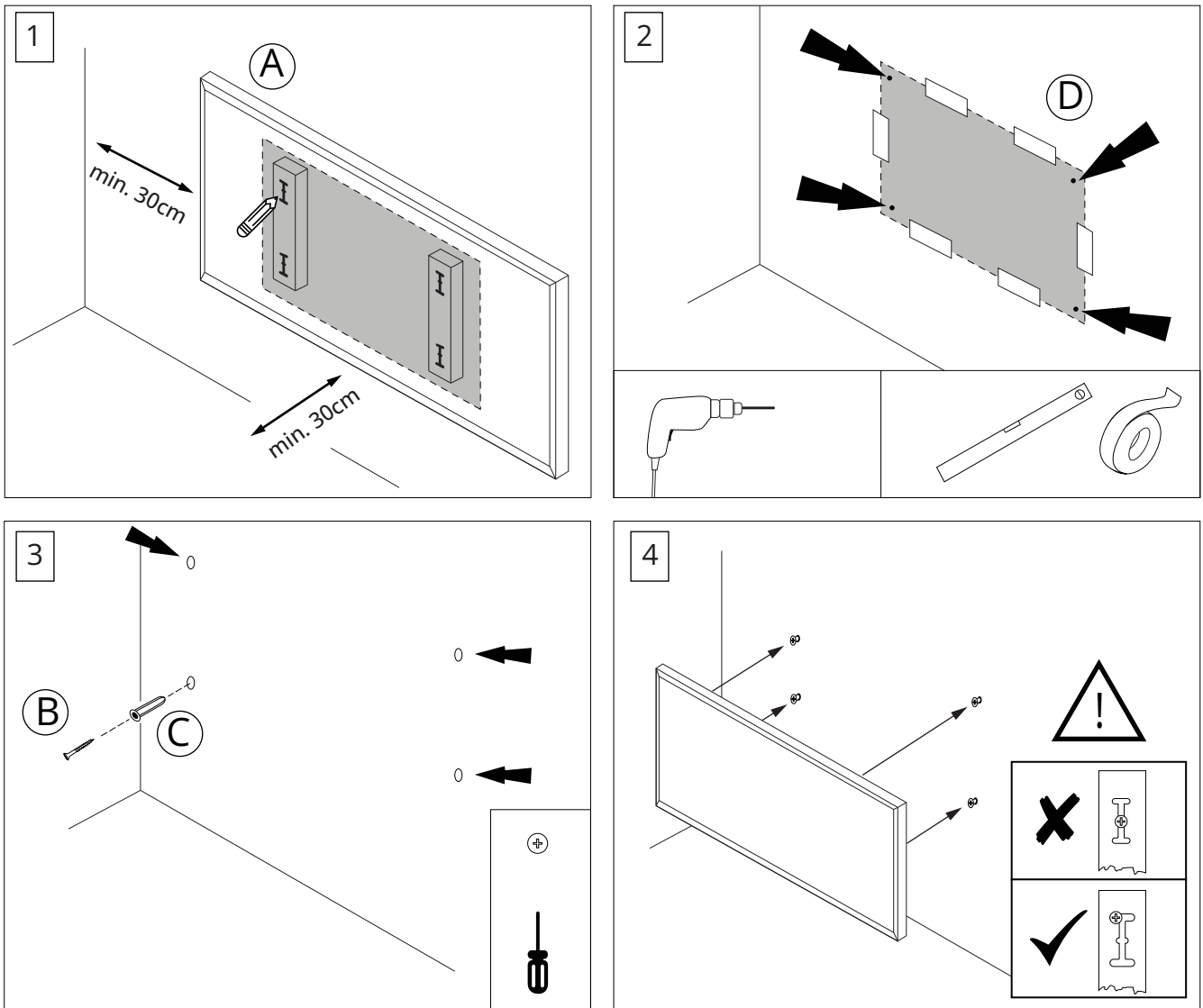

1. Use the supplied paper to cover the back of the panel, and use a pencil to mark the locations of the holes.
2. Use some double sided adhesive tape to fix the paper onto the wall or ceiling. Use this template to drill the holes.
3. Insert the wall plugs into the holes.
4. Insert the screws into the wall plugs. The screws should protrude from the wall by around 5mm.
5. Mount the panel onto the 4 screws.

# GLASS/MIRROR INFRARED HEATING PANELS



# INCLUDED IN THE BOX

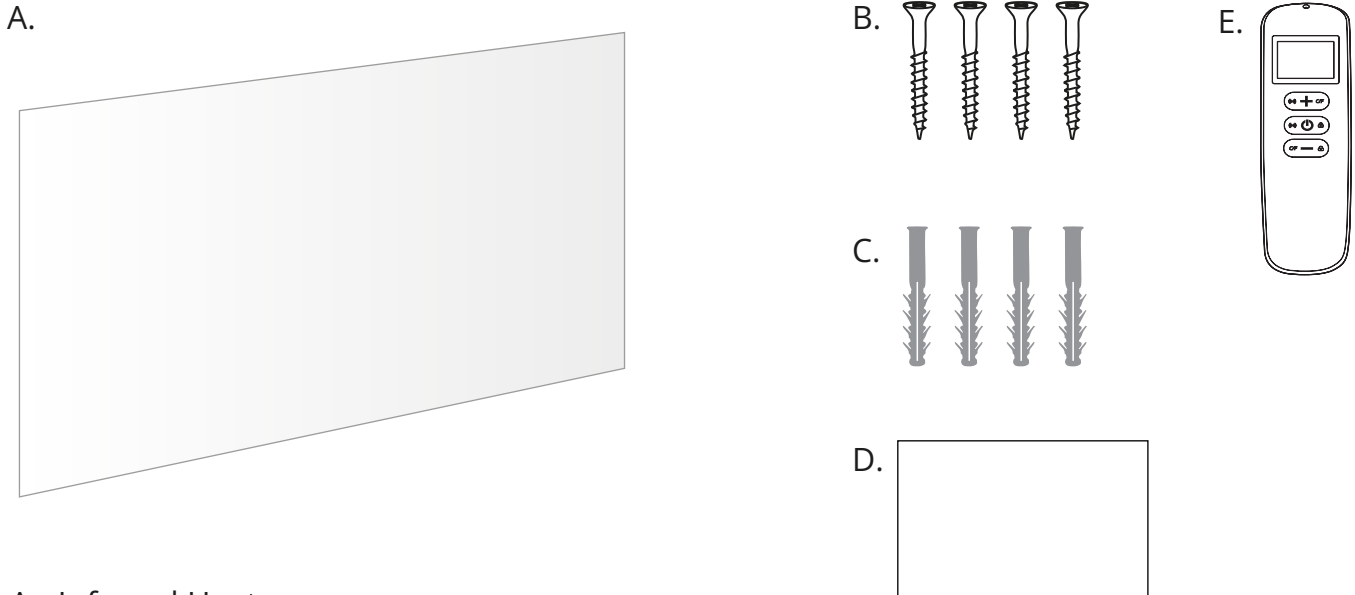

- A. Infrared Heater
- B. Screws
- C. Wall Plugs
- D. Mounting Template
- E. Remote Control (ONLY provided with Nexus, Glass and Mirror IR Heating Panels)

- This infrared panel heater is designed to provide an efficient, comfortable and healthy heating system for all domestic users and homeowners.
- This infrared panel heater can reduce air circulation and help create and maintain a clean, silent and dust free environment.
- All Glass and Mirror panels should only be installed on the wall, and should not be installed on the ceiling.
- A wide range of panels are available in varying sizes, wattages and frames.

# DEVICE STRUCTURE

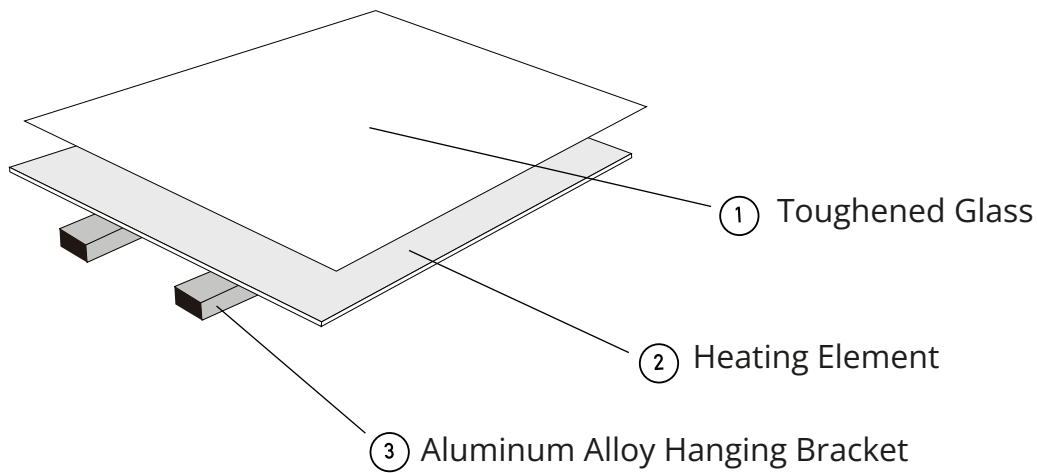

- The toughened glass ensures that your panel is durable enough for daily use.
- The carbon crystal heating element will distribute clean and efficient infrared heat throughout your space.
- The hanging bracket can be used to hang your panel on the wall, or used alongside your suspension kit or ceiling bracket.

You may need more than one panel to sufficiently warm your room. To calculate how many watts you will need, use the following formula.

Length (m) x Width (m) x Height (m) = Volume (m<sup>3</sup>)

For well insulated properties: Volume (m<sup>3</sup>) x 25 = Wattage Requirement

For moderately insulated properties: Volume (m<sup>3</sup>) x 30 = Wattage Requirement

For poorly insulated properties: Volume (m<sup>3</sup>) x 35 = Wattage Requirement

# WALL INSTALLATION

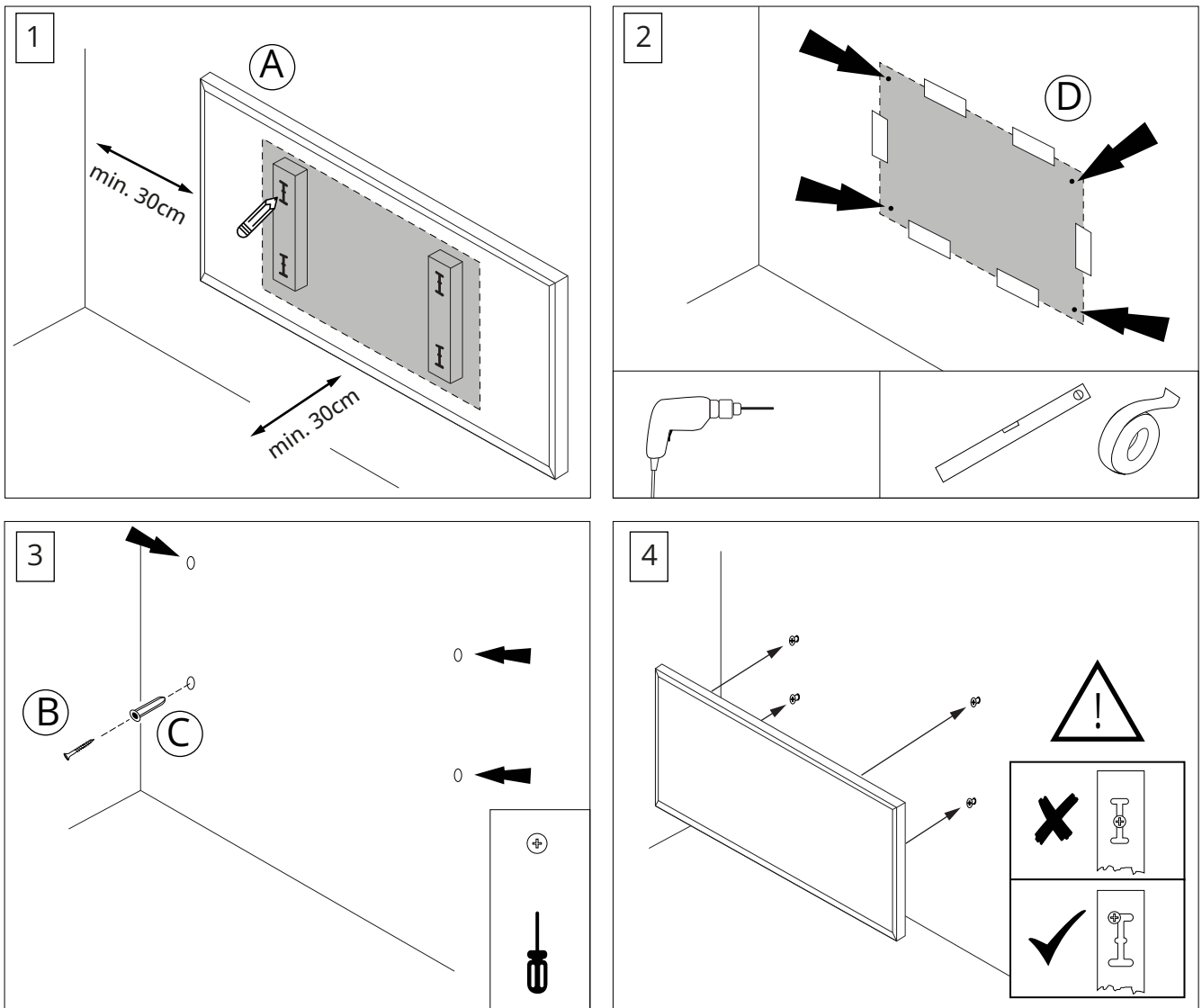

1. Use the supplied paper to cover the back of the panel, and use a pencil to mark the locations of the holes.
2. Use some double sided adhesive tape to fix the paper onto the wall or ceiling. Use this template to drill the holes.
3. Insert the wall plugs into the holes.
4. Insert the screws into the wall plugs. The screws should protrude from the wall by around 5mm.
5. Mount the panel onto the 4 screws.



# NEXUS FEATURES FOR NEXUS/ GLASS/MIRROR INFRARED HEATING PANELS

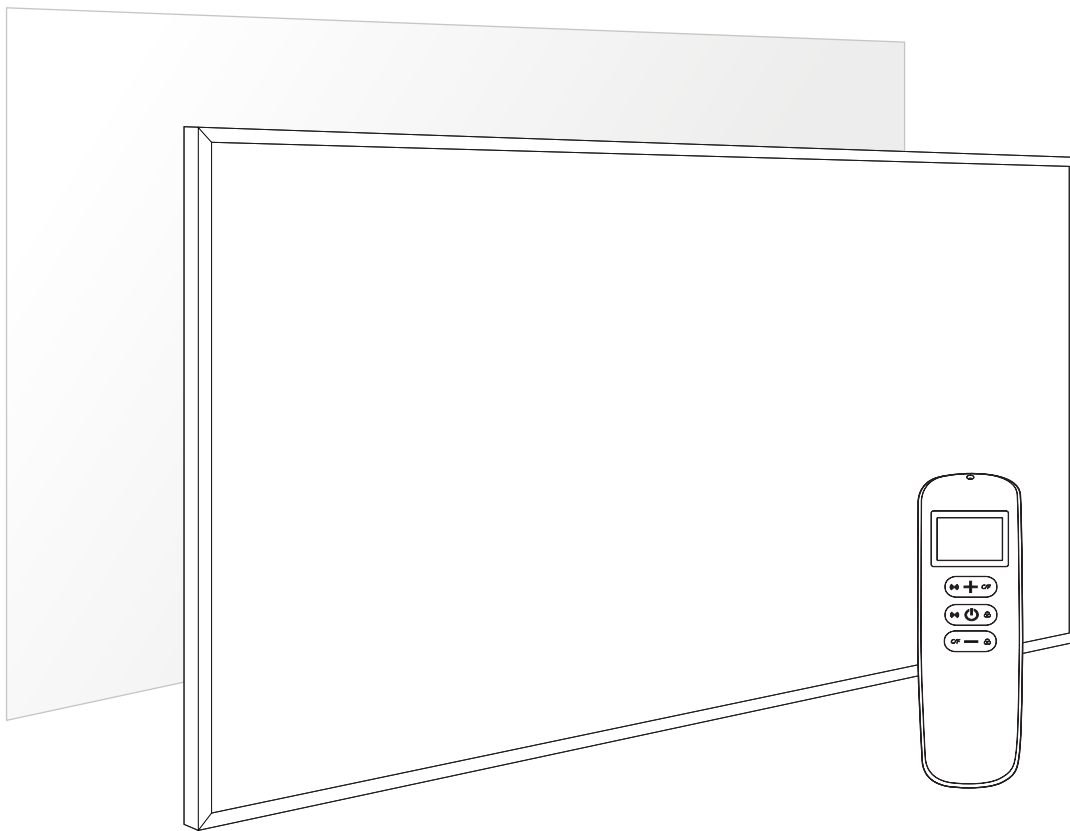

---

# NEXUS WI-FI REMOTE CONTROL SPECS

Nexus Infrared Remote and Nexus features ONLY available with Nexus, Image, Custom Image, Glass & Mirror Infrared Heating Panels.

## REMOTE CONTROL

- Battery Powered: DC 3V (2 x 1.5V AAA batteries, not included)
- Consumption: 3V 0.1mA
- Dimensions: 140mm x 40mm x 18mm
- Weight: 40g
- Temperature Setting Range: 0 °C- 45 °C
- Temperature Display Range: 0 °C- 50 °C
- Working Range: 8m

## BUILT-IN NEXUS WI-FI RECEIVER SPECS

- Power Supply: AC 220-240V
- Power Consumption: 0.8W
- Working Environment Temperature: -5 °C - 50 °C, Humidity: 10% - 95%
- Wireless Standard: IEEE802.11b/g/n
- Frequency Range: 2.412 – 2.484GHz
- Security Protocol: WEP/WPA-PSK/WPA2-PSK
- Encryption Protocol: WEP/TKIP/AES

## NEXUS WI-FI REMOTE CONTROL DIAGRAM

The remote control and integrated receiver allow full control of the operation of the heater.

The remote control reads the current room temperature using a sensor located at the top of the unit, and sends real time data to the receiver.



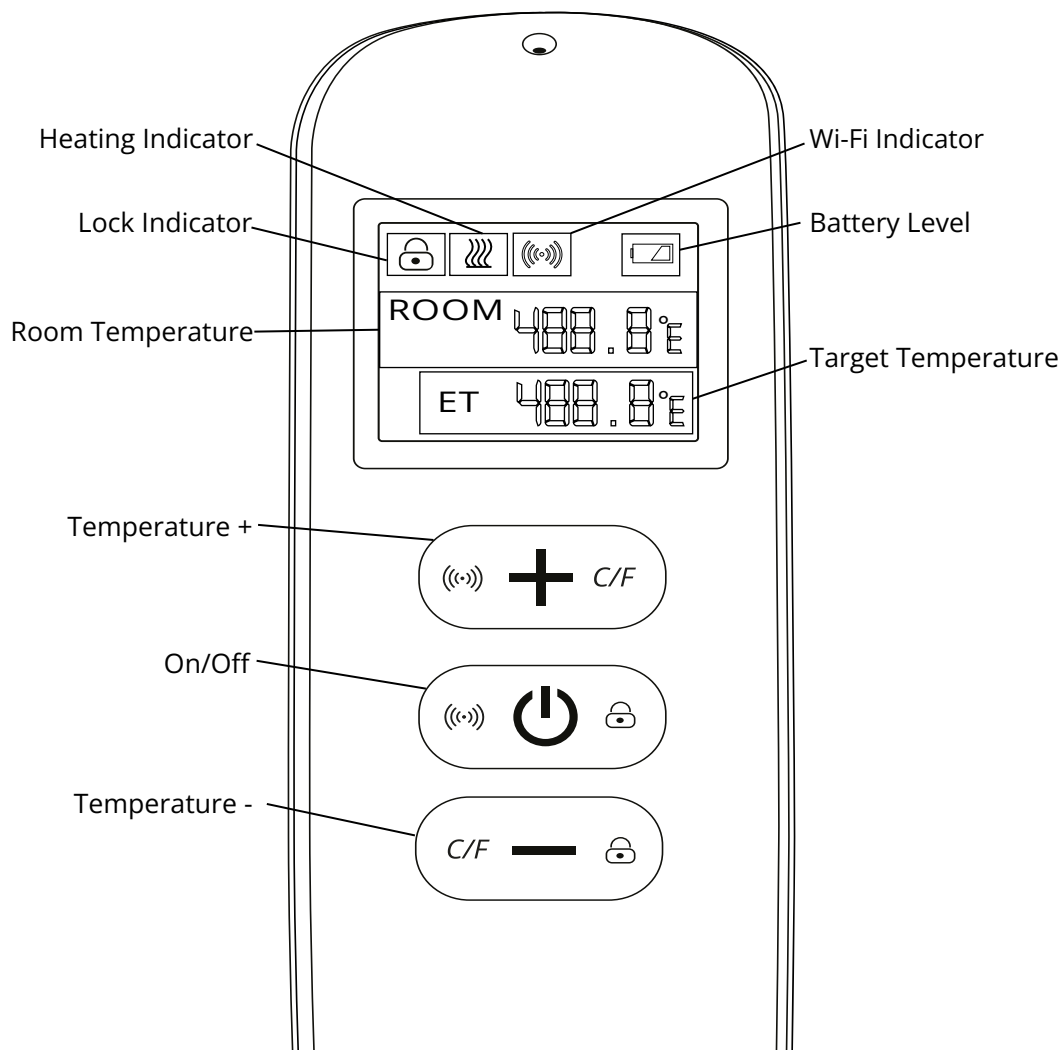

The screen on the remote control can display the current room temperature, target temperature, lock status, battery level, heating status and Wi-Fi status.

When the screen on the remote control is off, this means that the heating panel is off too. While in this state, the remote is still sending real time data to the receiver every 60 seconds.

It is possible to use a single remote and pair it with multiple heating panels.



## NEXUS WI-FI REMOTE LCD DISPLAY

- The “” symbol indicates when the IR Panel is beaming out heat.
- The “” symbol indicates that the button on the remote controller are locked.
- The “” symbol indicates when your heater is connected to your Wi-Fi network.
- The “” symbol shows you the current battery level. It will begin to flash when the battery level is low. At this point, you will need to replace the batteries.

## BUILT-IN NEXUS WI-FI RECEIVER DIAGRAM

### GLASS/MIRROR PANELS WI-FI RECEIVER DIAGRAM

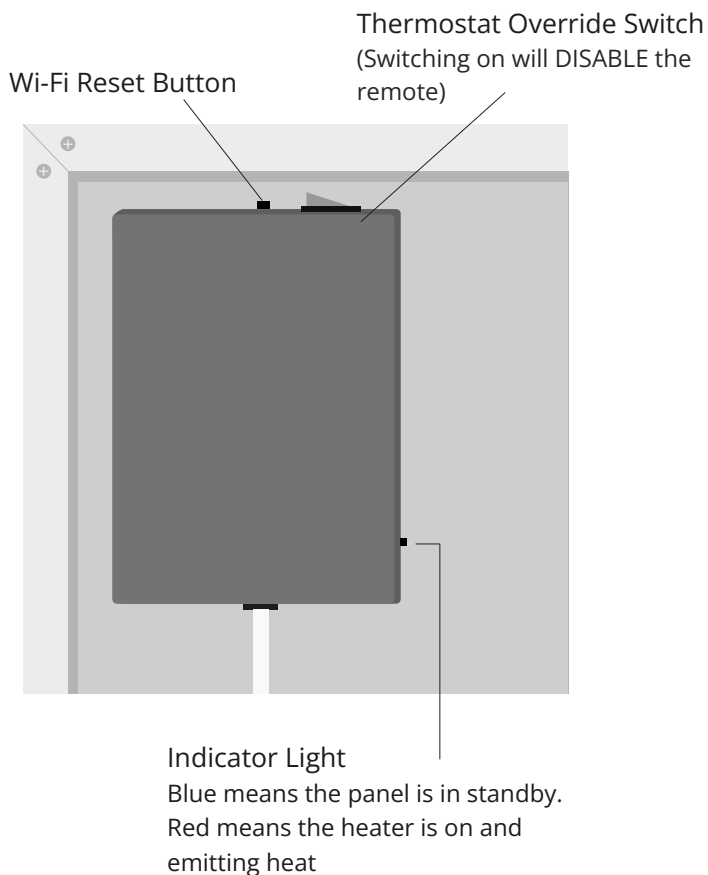

### NEXUS WI-FI RECEIVER DIAGRAM

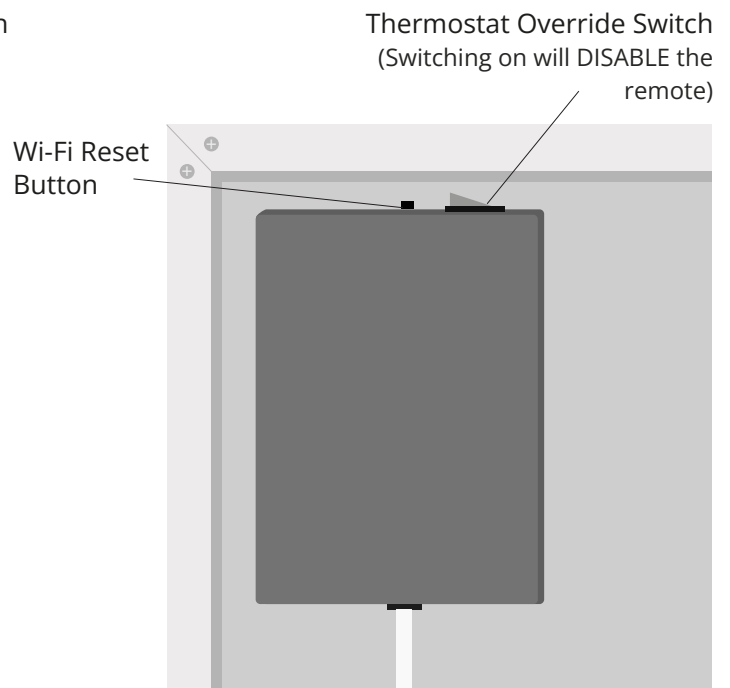

## PAIRING YOUR NEXUS WI-FI REMOTE

---

For a full video guide on how to use your remote with your Nexus/Glass/Mirror IR panel, please scan the QR code.



Before starting, please ensure that you have inserted 2 x 1.5V AAA batteries into the remote control.

Power on your panel heater by connecting it to a plug socket, using the 3-pin plug at the end of the flex cable.

Next, switch your remote control on by pressing the On/Off button.

To pair your remote with your panel heater, press the On/Off Button and temperature + button together within 60 seconds of switching your panel heater on. You will see the Wi-Fi symbol flash three times.

If the pairing has been successful, you will hear a beep from the heater.

*Please note:*

*Ensure that any panel heaters that you do not want pairing are switched off.*

*If your remote control needs replacing at any point in the future, power off the heater, then power it back on again. You can repeat the pairing process as described in the Initial Setup section, but you will have 5 minutes rather than 60 seconds.*

## BASIC FUNCTIONS

---

- You can use the On/Off button to turn your heater on and off.
- Press the 'C/F toggle button' to change between Celsius and Fahrenheit temperature displays.
- Hold down the 'Lock button' for 3 seconds to lock the remote, and hold it again for 3 seconds to unlock the remote.

---

# ELECTRONIC TEMPERATURE CONTROL

---

- To increase the target temperature by 1 °C, press the Temperature + button. Similarly, to decrease the target temperature by 1 °C, press the Temperature - button.
- Alternatively, you can hold down the Temperature + or Temperature - buttons to increase or decrease the target temperature continuously.
- If the target temperature is higher than the current room temperature, you will see the heating indicator appear on the screen, and the heater will switch on.
- If the target temperature is lower than the current room temperature, the heating indicator will be off on the screen, and the heater will switch off.

## ADVANCED FEATURES

---

- To switch your temperature display from °C to °F, press the temperature + and temperature - buttons at the same time.
- To lock your remote control, press the On/Off button and temperature - button together and hold for 3 seconds. Upon successful locking, you will see the lock indicator appear on the screen. Repeat this process to unlock the heater.

*Please note:*

*The backlighting on the screen will illuminate when you press any button, and will remain on for 5 seconds if no other buttons are pressed.*

# CONNECTING YOUR NEXUS PANEL TO WI-FI

---

Scan QR code for video instructions on how to pair your Nexus/Glass/Mirror panel to your home Wi-fi Network.



## Before you start:

1. Please make sure your phone/tablet/smart device is connected to a 2.4GHz Wi-Fi signal. All Wi-Fi routers emit a 2.4GHz signal, but some newer models emit both 2.4GHz and 5GHz. You can normally tell which signal is which by the name of the wireless network. 5GHz networks will usually contain a "5", "5G" or something similar in its name.
2. To download the Smart Life app, iPhone and iPad users can scan the QR code below to the left, and Android users can scan the code below to the right. You'll need to create an account if you haven't already.



3. Make sure your panel is switched on, and that the green override switch on the back of the panel is switched off.

4. In the Smart Life app, select the add device button, then 'Small home appliances.' Then select 'Wi-Fi Heater'. You will be prompted to enter your Wi-Fi password, but don't do so yet.

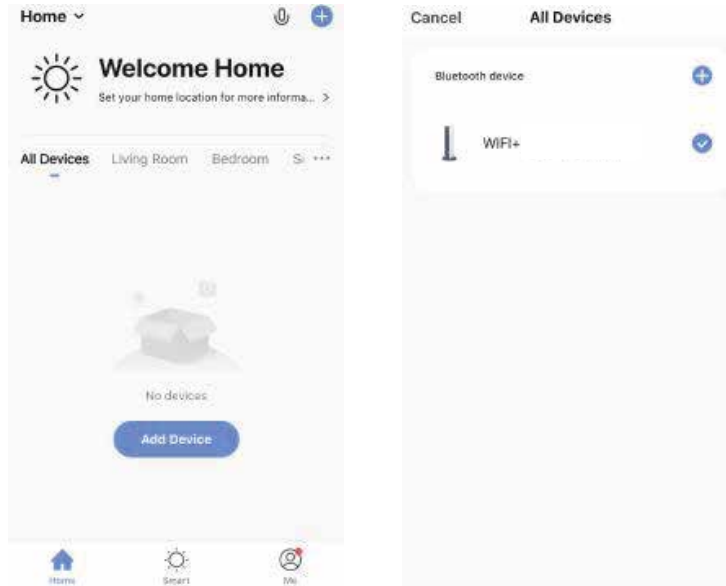

5. On the back of the panel, press and hold the Wi-Fi reset button for at least five seconds. The indicator LED on the front of the panel will start to blink rapidly. Press and hold the Wi-Fi reset button again for five seconds, and the LED will blink slowly, showing it is ready to be paired.

**NEXUS IR PANELS**

Indicator Light  
Blue means the panel is in standby.  
Red means the heater is on and emitting heat

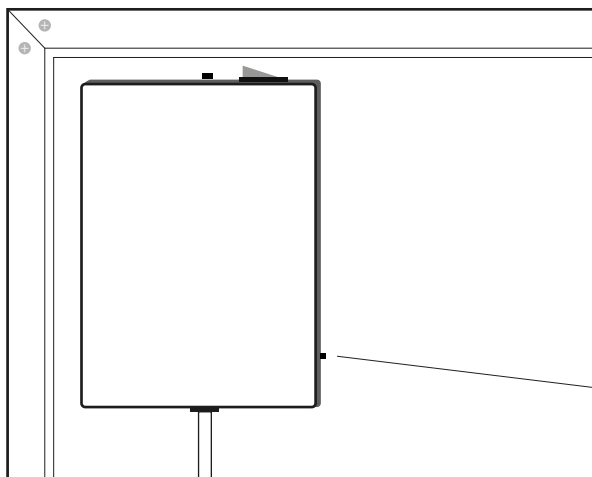
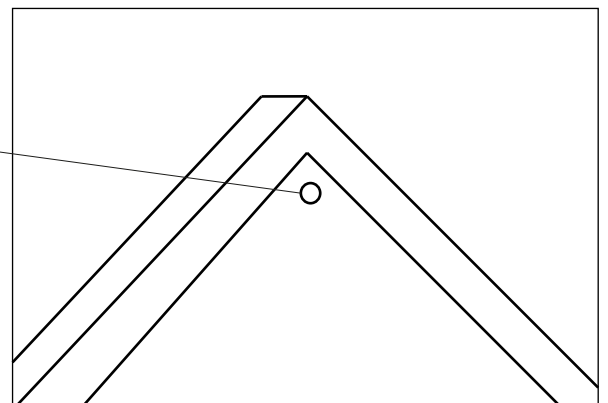

**GLASS/MIRROR PANELS**

Indicator Light  
Blue means the panel is in standby.  
Red means the heater is on and emitting heat



6. Enter your Wi-Fi password.

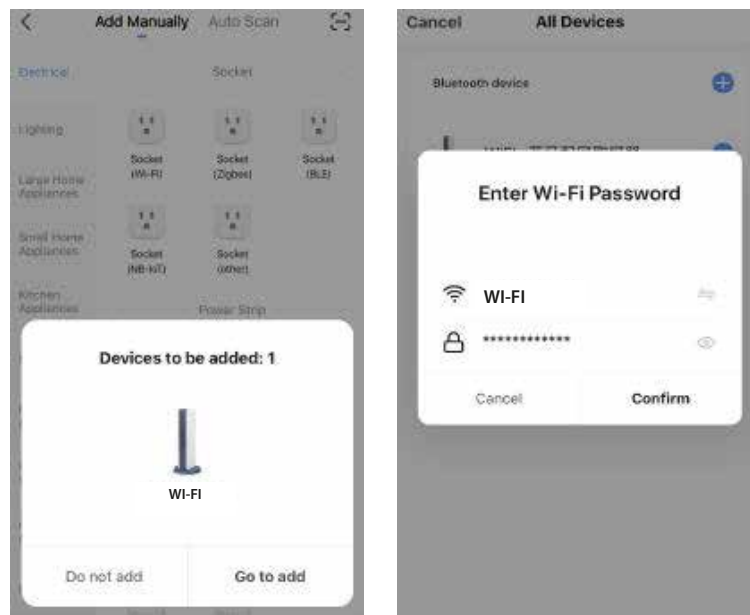

7. Confirm the light on the panel is blinking slowly.

8. The app will now ask you to connect your phone to the device's hotspot. Follow the prompts provided to do so. If the phone prompts you, tell it you only wish to connect to this network once.

9. The app will now search for your heater, and should connect within 30 seconds or so.

10. Once this is complete, you can name your heater to help you keep track of it easily.

---

## NOTES

- The Nexus/Glass/Mirror Wi-Fi IR Panels only support 2.4GHz networks, and are not compatible with 5GHZ networks.
- When the LED indicator on the front of the Nexus Panel/back of the Glass/Mirror Panel is blue, it means the heater is powered on but on standby. When the LED indicator is Red, this means the heater is heating up.
- To clear the Wi-Fi settings on the panel, you can either press and hold the Wi-Fi reset button on the back of the panel for approximately 5 seconds, or you can power the heater on and off 4 times at the plug socket.
- When the green remote override switch on the back of the panel is ON, the remote control will not function.
- If the heater loses connection with the Wi-Fi network, the heater will power off.
- Please use an alkaline battery in the remote control.
- Please ensure that the remote is always no further than 8 metres away from the heater.
- Do not block the temperature sensor, located on the top of the remote control.
- Keep the remote control out in the room where your heater is installed, and avoid putting it in a drawer, in your pocket, under a pillow or anywhere else where the temperature sensor may be blocked, as this may result in the heater not functioning correctly.
- If you will not be using the heater for a prolonged period of time, it is best to remove the batteries from the remote.
- Do not use the heater in areas where there are high concentrations of water, eg, zone 1 of your bathroom, outdoors etc.
- If your remote control unpairs from your panel, bring the remote no more than 3 metres away from the panel and re-pair them together.
- If the panel loses connection to the remote for 1 hour or more, the Smart Life app will display "--.--", and the heater will continue to operate based on the last received room temperature. The app will display the correct room temperature once the connection to the remote is re-established.

---

# MAINTENANCE & SERVICING

---

1. This infrared heating panel requires no servicing, and very little maintenance.
2. When cleaning any Classic , Frameless , Nexus , Glass or Mirror IR panel, you can use a damp cloth and gently wipe the surface of the panel. 3. When cleaning any Image or Custom Image IR Panel, use a dry cloth to gently wipe the surface of the panel to prevent any damage to the ink.
3. Dismantling or attempting to repair the panel yourself should not be done under any circumstances, as this will immediately void your warranty.

# TROUBLE SHOOTING

Symptom	Cause/Solution
The heater will not turn on	Double check that the heater is connected to a power source, and that there is no damage to the flex cable.
	Try connecting a working electrical appliance to the same socket to determine the circuit is working.
	If the heater has a manual on/off switch, check that it is in the 'on' position.
	If your heater utilises a remote control, ensure that the batteries have not ran flat by swapping in new batteries.
There is a strange smell coming from the heater	This is normal upon first use, as the heating element burns off the protective oils used to guard it during transit.
The heater is overheating	Switch the heater off at the mains and let it cool down completely. Switch the heater back on and if the problem persists, contact the retailer immediately.
The heater is overheating	If you are using a thermostat, this may be causing the issue. Either try a different thermostat or contact your local electrician to investigate the symptom.
	If your panel is ceiling mounted, ensure that there is adequate gap between the ceiling and the panel by lowering the suspension cable.
The heater is not warming the room up.	Your heater may not be the correct power for the room. Consult our wattage calculator located on every product page to determine the correct number of heaters for your room.
The heater is making a strange noise	This is normal upon first use, and can persist longer term to a lesser extent. The reason is that the heating element will expand slightly as it gets hotter, and then contract slightly when it cools. retailer immediately.
I don't know how to use a function on the NXT Gen remote	Please refer to page 23 for full details of the NXT Gen remote functionality.

- When installing the panel on your ceiling, you must use a Suspension Kit and leave a space of at least 50mm between the ceiling and the panel, or use a Ceiling Bracket. Our panels can be installed on your wall in both portrait and landscape orientations.
- Before drilling any holes or making any other permanent modifications to your home, please ensure that the panel(s) you have are sufficient for the room you're installing them in. You can calculate your cubic space by multiplying the Length by the Width, and then multiplying the result by the Height of your room, all in Metres. This will give you the cubic capacity of your room in m<sup>3</sup>. Then, if your home is well insulated, multiply your cubic capacity by 25 to give you your required wattage. If your home is moderately insulated, multiply your cubic capacity by 30, and if your home is poorly insulated, multiply your cubic capacity by 35.
- The above calculations are based on optimum conditions. If you feel your room or property does not meet optimum insulation, shape, dimensions or anything else, please consult a sales agent before purchase.
- Once installed, you may begin to notice dark marks appear on your wall and ceiling, and even on the heater itself. This is completely normal, and happens with all heaters. It is the result of dust, dirt, and external gases staining surfaces in the vicinity of the heater as a result of the movement of air around the heater itself. This is nothing to be concerned about, and will not affect the operation of the heater.

## DISPOSAL

---



Electrical appliances such as this infrared heater should not be disposed of with other household waste, and should be recycled at special facilities. Check with your local authorities or retailer for advice concerning disposal and recycling.

# MIRRORSTONE

INFRARED HEATING



[sales@mirrorstone.co.uk](mailto:sales@mirrorstone.co.uk)

[www.mirrorstoneheating.co.uk](http://www.mirrorstoneheating.co.uk)

86 Scudamore Road Leicester, LE3 1UQ

+44 (0) 116 436 2250